



Norman, K., Adriaense, J., & Nicol, C. (2019). The impact of early structural enrichment on spatial cognition in layer chicks. *Behavioural Processes*, 164, 167-174.
<https://doi.org/10.1016/j.beproc.2019.05.008>

Peer reviewed version

License (if available):
CC BY-NC-ND

Link to published version (if available):
[10.1016/j.beproc.2019.05.008](https://doi.org/10.1016/j.beproc.2019.05.008)

[Link to publication record in Explore Bristol Research](#)
PDF-document

This is the author accepted manuscript (AAM). The final published version (version of record) is available online via Elsevier at <https://www.sciencedirect.com/science/article/pii/S0376635719300385> . Please refer to any applicable terms of use of the publisher.

University of Bristol - Explore Bristol Research

General rights

This document is made available in accordance with publisher policies. Please cite only the published version using the reference above. Full terms of use are available:
<http://www.bristol.ac.uk/red/research-policy/pure/user-guides/ebr-terms/>

The impact of early structural enrichment on spatial cognition in layer chicks.

Kate I Norman^a, Jessie E.C Adriaense^{abc} and Christine J Nicol^d

^aBristol Veterinary School, University of Bristol, Langford House, Bristol, BS40 5DU, U.K.

^bDepartment of Cognitive Biology, University of Vienna, Althanstrasse 14 (UZA1)
1090 Vienna, Austria

^cSCAN-Unit, Department of Basic Psychological Research and Research Methods, University of Vienna, Liebiggasse 5, 1010 Wien

^dRoyal Veterinary College, Hawkshead Lane, Hatfield, Hertfordshire, AL9 7TA, U.K.

Corresponding Author:

Kate I Norman

Kate.norman@bristol.ac.uk

Other authors:

Jessie E.C Adriaense

jessie.adriaense@univie.ac.at

Christine J Nicol

cnicol@rvc.ac.uk

The aim of the study was to determine whether early access to elevated structures affects spatial navigational abilities. Ninety six day-old chicks were reared in 16 pens. Eight pens were provided with A-frame perches with an attached platform and a ramp. Eight pens had no elevated structures. At 14-15 days of age 48 chicks were tested in a battery of navigational tasks: a detour test, jump test and rotated floor test (RFT). The remaining 48 chicks received the same tests at 28-29 days of age. Chicks reared with elevated structures were faster at completing the detour test ($P=0.045$). Older chicks were more likely to turn left in the detour test ($p=0.013$) and were more successful in the jump test (69% vs 31% completion, $p=0.001$). There was no treatment effect on use of intra or extra-maze cues in the RFT, but the proportion of chicks using intra-maze cues declined between the first (0.76) and second (0.43) repeat of the RFT ($p=0.038$), particularly for chicks reared with elevated structures. We conclude that bird age or developmental stage may have a predominant influence on spatial navigation and physical ability, but early experience of elevated structures had some mediating effects which require further investigation.

1 Keywords

Layer chicks; Structural enrichment; Spatial cognition; Rearing experience

2 Introduction

A growing proportion of laying hens are being housed in non-cage systems. Whether single, or multi-tier (aviary), these systems can be complex for birds to navigate. Resources such as food, water, nest boxes and litter are distributed throughout the system and on multiple levels in aviary houses. Successful movement within these systems and into outdoor areas, if available, will be influenced by the birds' general cognitive abilities and their specific spatial navigation skills.

Most hens are reared in separate facilities to 15-18 weeks of age, then transferred to the laying system. It is recognised that rearing environment should be tailored to the laying environment (Janczak and Riber, 2015). For example, birds reared in aviaries show reduced keel bone fractures when also housed in aviaries at lay compared to cage reared birds (Casey-Trott et al., 2017). If chicks destined for aviary systems cannot be reared in aviaries, then they may instead be provided with elevated surfaces within a single-tier house. These structures tend to be table platforms and perches. There is evidence that early access to perches prior to 4 weeks of age reduces floor eggs and cloacal cannibalism and may have other welfare benefits (Appleby et al., 1986, Gunnarsson et al., 1999, EFSA, 2015). However, more research is needed to explore the importance of timing and the exact type of experience needed with elevated structures to minimise later welfare problems. The RSPCA standards state that birds must have perches by 10 days of age, and recommend perches are raised 25cm off the floor (RSPCA, 2016). However, 10-day old chicks might not use perches at this recommended height to their full potential, and earlier access to lower perches might increase usage. Heikkila et al. (2006) observed the first chick using perches at a height of 20cm from the floor by 8 days of age, and all chicks were using perches by 22 days of age, suggesting a desire to perch from a young age. Facilitated access (using ramps or staged perches) may be even more beneficial. Our own work has shown that access to ramps during the rearing period improved ramp transitions in older pullets, shown by reduced hesitancy behaviour and shorter transitioning latencies (Norman et al., 2018). A preference for grid ramps over ladder ramps was found suggesting the type of ramp should also be considered (Pettersson et al., 2017).

The provision of elevated structures to young birds in commercial systems has primarily been driven by the desire to facilitate more movement, so that when pullets are moved to the laying system they are more mobile. This may in turn reduce welfare problems such as later cloacal cannibalism (Gunnarsson et al., 1999), keel bone damage (Wilkins et al., 2005, Wilkins et al., 2011) and feather pecking (Campbell et al., 2018, Lambton et al., 2010, Nicol et al., 2013, Lambton et al., 2013). However, elevated structures can also be regarded as a form of environmental enrichment which is likely to affect brain development and cognition (Campbell et al., 2018). Exposure to an enriched

environment compared to a barren one from a young age can improve spatial memory in mammals (Sneddon et al., 2000, Kobayashi et al., 2002). For example, increased neurogenesis in the dentate gyrus of the hippocampus, a brain region important for memory, is observed when rodents are housed in enriched conditions (Kempermann et al., 1997). Similarly, chicks reared with ground-level visual barriers (opaque screens) demonstrate improved spatial memory (Freire et al., 2004), and have longer dendrites and more spines per dendrite in the hippocampus, which may lead to improved encoding of relative positional information (Freire and Cheng, 2004).

Further work is needed to understand if the elevated structures now commonly provided for chicks have any influence on their spatial cognitive abilities. Gunnarsson et al. (2000) reared chicks with or without perches to 8 weeks of age and tested them at 16 weeks of age in a navigational task requiring birds to jump between raised platforms to reach a food reward. Birds raised with or without perches were equally likely to jump to a 40cm platform, but birds raised with perches were both more likely to jump to a single 80cm platform (suggesting improved physical competence) and more likely to jump from a 40cm to an 80cm platform. This latter result implies improved navigational ability, however, it cannot be excluded that this result was also due to perch-reared birds possessing greater confidence in jumping at height due to increased physical strength. For this reason, further work using tasks that more clearly separate potential physical and cognitive components of navigation would be useful. The age at which structures are provided may also be highly relevant. A rise in perching behaviour at 9 to 10 days of age followed by a fall at 11 days of age coincides with a shift in brain activity to the right hemisphere in the hippocampus (Workman and Andrew, 1989). At this same age, chicks voluntarily seek to move out of sight of the hen and then to regain contact, providing them with experience of visual occlusion. The provision of artificial visual barriers at 10-12 days of age improves chicks' ability to use external cues in detour tests and hidden food reward tests, but these improvements in spatial cognition do not occur if visual barriers are provided at 8 days of age and removed by 9 days (Freire and Rogers, 2007). This provides evidence of a sensitive period during which experience of visual occlusion is particularly beneficial in brain development for spatial navigation. The importance of gaining perching experience during this shift in brain activity has not been explored.

Cognitive tasks where differences in physical strength are unlikely to play a major role include the hole board task, detour tasks and rotated floor tasks. The hole board task requires a subject to use both reference and working memory to locate food rewards hidden in various cups on the floor. Tahamtani et al. (2015) compared the performance of birds reared in either cages or aviaries in a hole board task and detected better working memory and reversal learning in aviary reared birds tested at 16 weeks of age. In a study looking at associations between cognition and feather pecking

Nordquist et al. (2011) also used the hole board task with 25 day old chicks. However, one problem with this test is that it can take up to 12 days of habituation and 28 days for the different training and test phases. Experience during long term training may influence navigational development in the control chicks and impact their ultimate test performance. The detour test requires a subject to navigate out of a U-shaped pen to gain access to its companions. The rotated floor test (RFT) requires a subject to associate intra- or extra-environmental cues with the location of its companions. All of these have been used previously in studies with chickens. Other studies have detected early experience effects on spatial cognition using detour tests (Freire et al., 2004, Wichman et al., 2007) and RFT for chicks (Wichman et al., 2009), both with very little training required.

In this study we therefore used both the detour and RFT to look at the effect of elevated structures on different aspects of navigation during the first four weeks in the chick's life. Both tests require minimal training and assess birds in a two-dimensional environment where differences in physical ability should play a minor role. We also examined the effect of elevated structures on performance in a three-dimensional jump test adapted from Gunnarsson et al. (2000). This test confounds physical and cognitive ability but provides a good comparison point with the previous work by Gunnarsson et al. (2000) on older birds.

3 Methods

3.1 Animals and housing

Ninety-six British Black Tail (*Gallus gallus*) day-old female chicks were used for testing. Four extra chicks were purchased to account for any mortalities, and two of these were used to replace two chicks that died in the first few days. The day after hatching chicks arrived at the facility and were housed in four rooms with four pens per room (1.5m x 1m) and 6 chicks per pen (two treatment pens had 7 chicks per pen, these extra chicks were not tested). All pens had wood shavings for litter and a heat lamp. Chicks were fed *ad libitum* chick crumb (in small troughs and upgraded to feed hoppers by 2 weeks of age) and provided with bell drinkers. The light schedule was 12 hours on 12 hours off (07:30 to 19:30). Room temperature was slowly reduced as the chicks aged and the heat lamps were removed at 2 weeks of age.

Eight treatment pens (two per room) had elevated structures (see figure 1). These comprised 8 wooden perches (each length 60cm, 2cm diameter) arranged in an A-frame (three perches at height 10cm, two at 25cm, two at 40cm and one at 60cm) and a plastic grid platform (width:30cm x length:30cm) situated on one side of the A-frame, partially covering the perches at height 25cm. A

plastic grid ramp (length:40cm x width:30cm at 40° from ground level) led from the floor to the platform on the A-frame. The other 8 pens were controls with no elevated structures. From day 1 chicks were encouraged to feed and drink by tapping on feed bowls and dipping their beaks in water. Between 5 and 9 days of age chicks were handled once per day and bowls of feed were placed in the pen to encourage habituation to human presence. From 10 to 27 days of age (excluding the 4 testing days) all chicks were habituated to handling by feeding oats in a bowl and transferring them to cardboard boxes regularly. At 12 days of age coloured leg rings were fitted to each chick to allow individual identification. Chicks were weighed each week to ensure even growth.

Figure 1 location

3.2 Use of elevated structures

Recordings of use of the elevated structures in the treatment pens were taken each day from 1 to 26 days of age. Eight GoPro cameras (Hero5) were set up in each treatment pen to take pictures of the structures during the light period every 10 minutes over three hours each day, giving 19 recording time points over the day. Recording times were either in the morning or afternoon to avoid disturbance by the feeding or habituation schedule of the day. The earliest recording period was 09:00 to 12:00 and the latest was 16:30 to 19:30. All eight cameras were set up to record at the same time across all treatment pens. The numbers of chicks on the perches, platforms and ramps were counted.

3.3 Navigational tests

Chicks were tested in three navigational tasks: the detour test, jump test and rotated floor test (RFT). Forty-eight individually identifiable chicks (3 per pen) were tested on all three tests at 14-15 days of age and 48 (the remaining 3 chicks per pen) were tested on all three tests at 28-29 days of age. The navigational tests were carried out by two researchers over two days. The tests were systematically balanced for order to account for differences in experience. The researchers worked at the same time testing 12 chicks each from two of the rooms in one day, swapping between all three navigational tests. Each navigational test was video recorded using a GoPro camera. The ID and pen number of each chick was read out loud before the start of the test to ensure identification.

3.3.1 Detour test

The detour test (Wichman et al., 2007, Freire et al., 2004, Wichman et al., 2009) (see figure 2) was conducted within a cardboard arena (L 60cm x W 60cm x H 43.5cm). Three familiar chicks (reared in the same pen) were placed in the holding compartment at point A (25cm x 25cm) with a view into the arena. Some oats were sprinkled on the floor and once all chicks were pecking at the oats the test chick was moved to the detour compartment at point B (20cm x 22cm) and placed on a central

cross facing the companions through the mesh. The detour compartment was rectangular, with two solid sides and a front wire mesh side facing the holding compartment. The aim of the test was to assess the chick's ability to navigate out of the detour compartment to reach its companion chicks. Orientation errors were recorded whenever a chick's head or whole body crossed the orientation error lines then re-crossed without crossing the goal lines. The time taken for the chick's head to cross the goal lines was recorded. Each chick was given a maximum time of 5 mins, at the end of testing or upon completion the test chick was returned to the holding compartment and the next chick was placed in the detour compartment.

Figure 2 location

3.3.2 Jump test

The jump test adapted for chicks (Gunnarsson et al., 2000)(see Figure 3) was conducted within a wooden box with a mesh front (W 40cm x L 40cm x H 60cm). There were two trials, in the first trial, chicks had to negotiate one level to regain contact with companions placed within a small wire mesh holding compartment (22cm x 22cm) on the lower platform (point A1). In the second trial they had to negotiate two levels to regain contact with companions placed within the holding compartment on the upper platform (point A2). Once all chicks were ground pecking at oats on the floor of the holding compartment the test chick was removed and placed at point B on the floor. The latency for each test chick to jump up to the platform was recorded. A maximum of 5 minutes was given, if the chick did not jump it was returned to the holding compartment.

Figure 3 location

3.3.3 Rotated Floor Test

The RFT (Wichman et al., 2009, Freire and Rogers, 2005, Freire and Rogers, 2007) (see Figure 4) provided a training phase so that chicks could learn that their companions were behind one of two screens. They were then tested to see if they were relying on intra or extra-maze cues. A chick was recorded as using intra-maze cues if it used the screens as the cue to find its companions and extra-maze cues if the chicks used overall position as the cue. The apparatus was a rectangular area (L 175cm x W 61cm), with two screens placed at 42cm from each short side of the arena. The floor was covered with cardboard that could be wiped down or replaced to avoid any marks being left by previously tested chicks. A holding compartment could be placed behind either of the screens. One screen had a coloured pattern (red, blue, yellow and green), the other screen was a plain grey colour and the position of the screens was swapped for each chick. A circular starting compartment (20cm diameter made of wire mesh) was placed in the centre of the arena at point B. The initial training took on average 6 minutes and the first test took on average two minutes. The chicks had a two-

minute resting period between the training and testing, where all three chicks were transferred to a holding box outside the RFT arena, so the arena could be cleaned and set up for the next subject.

For the first training session all 3 chicks were initially placed in a holding pen behind one of the screens at point A1 or A2 (counterbalanced), with colour and position cues balanced across treatments. The test chick was then removed and placed in the central starting compartment, facing forwards with the screens to the left and right. After 5 seconds the starting compartment was removed. The test chick was given 1 minute to explore the arena. A chick was considered to have learnt the task when it went behind the screen where its companions were, within 1 minute, in two successive training trials (the training was stopped at this point). The chick was given 30 seconds to remain with its companions then replaced in the companion holding pen. If a chick did not go behind the screen with the companion chicks the researcher gently nudged the chick in the right direction using their hand. Each chick could experience a maximum of 6 training trials within the first training session. Any chick that had not reached the learning criterion after 6 trials, was classified as having not learnt the task and was not tested further.

The test phase for chicks that met the learning criterion followed the first training session. All chicks were removed from the arena, the screens were swapped to the opposite sides from training and the central starting compartment was replaced. The test chick was placed into the central starting compartment but this time there were no companion chicks. After 5 seconds the starting compartment was removed, and the chick could explore the arena. A maximum time of two minutes was allowed for the test. Recordings were taken if the chick crossed the marker lines, and the screen colour was noted down. If the chick chose the screen that the companions had previously been behind (opposite location) this was noted down as using intra-maze cues. If the chick chose the location where companions had previously been found (opposite screen colour) it was noted to be using extra-maze cues. The test was stopped when the chick went behind a screen. The chick was then removed from the arena and the training and testing sessions were repeated with the screens in the same positions as the first session, so each chick received two training sessions and two tests on one day.

Figure 4 location

3.4 Statistical analysis

Before analysis each video was re-coded by an independent researcher to ensure blinding of the videos. All data were analysed using both MLwiN (3.0) and SPSS 24 (IMB). All data met the assumptions of the statistical tests used, no transformations were required. Data pertaining to the use of the elevated structures were tested to look for a correlation between structure use and age.

The number of chicks that did not complete the detour test or jump test was similar between the treatments so chicks were removed from the analysis of latency to complete the tests to obtain a normal distribution. General Linear Models (GLMs) were used, with treatment and age as fixed factors, to look for differences in the latency to complete the detour, jump test and RFT. A binomial model (generalised linear model) was used to look at direction chosen for the detour test with treatment and age as variables. Binomial tests were used to compare the proportion of chicks choosing intra or extra-maze cues in the RFT. Count data (orientation errors) were analysed using a Poisson model. No interaction effects were found for any of the data. Only main effects are presented, and all results are presented in the format mean \pm SD.

3.5 Ethical approval

The University of Bristol's Animal Welfare and Ethical review body approved this study under UIN/18/012

4 Results

4.1 Structure use

Within the treatment pens, the use of the elevated structures increased over time. A strong, positive correlation between age and total structure use was found ($r=0.870$, $n=24$, $p=0.001$), (Figure 5). The total mean (over 19 observations/day) number of chicks observed on the structures over each day was calculated. There was a gradual increase in structure use with a peak at 10 days of age (0.21 average chicks/pen) followed by a fall at 11 days of age (0.11 average chicks/pen). This was followed by the highest peak at 12 days of age (0.27 chicks/pen) and continual fluctuations to 26 days of age. Figure 5 shows that over the first three days the ramp was predominantly used by chicks. Use of the platform increased up to 10 days of age and from 8 days of age there was a gradual increase in the use of the highest perches (P3 and P4).

Figure 5 location

4.2 Detour test

Out of the total 96 chicks that were tested at 14-15 and 28-29 days of age, 67 completed the detour test in under 5 minutes. Of the successful chicks 33 were from an enriched environment and 34 were from a control environment. The latency to complete the detour test was significantly lower in the enriched chicks (58.42 ± 52.52) compared to the control chicks (89.91 ± 73.73 ; $z=-2.005$, $n=67$, $p=0.045$) (Figure 6). There was no effect of age on the latency to complete the test ($z=-1.091$, $n=67$, $p=0.275$). Using a binomial model, there was a significant effect of age on the direction in which chicks tended to leave the start box ($z=-1.113$, $n=67$, $p=0.013$). At 14-15 days of age 37.5% went left

out of the detour box when view from above, whereas at 28-29 days of age 62.9% went left out of the detour box (Figure 7). There was no effect of treatment on direction to leave the start box.

There was a difference in the number of orientation errors between the groups tested at different ages, with fewer orientation errors at 14-15 days (0.17 ± 0.43) compared to 28-29 days (0.77 ± 1.23 ; $z=3.928$, $n=96$, $p=0.001$). There was no significant difference between treatments ($z=1.33$, $n=96$, $p=0.183$). There was a significant difference in the number of orientation errors and the completion of the detour test within 5 minutes ($z=-4.384$, $n=96$, $p=0.001$), with the successful chicks showing fewer orientation errors (0.27 ± 0.60) compared to the unsuccessful chicks (0.93 ± 1.41).

Figure 6 location

Figure 7 location

4.3 Jump test

There was a significant difference between ages for both trials of the jump test, but no effect of rearing treatment. Trial 1 (jumping up to 1 platform) was completed by 31% of birds at 14-15 days and 69% at 28-29 days of age ($z=3.909$, $n=96$, $p=0.001$). Trial 2 (jumping up both platforms) was completed by 23.4% of birds at 14-15 days and 76.6% at 28-29 days of age ($z=5.412$, $n=96$, $p=0.001$). There was no overall difference in the latency to complete the jump test between treatment or age.

4.4 Rotated floor test

When considering the number of chicks passing the training criteria for the first training session of the rotated floor test, 72.9% were successful at 14-15 days of age compared to 91% at 28-29 days of age. The successful chicks showed good consistency with only 3.8% of the previously-successful chicks being unsuccessful in the second training session. However, the number of training sessions was similar for the successful chicks, with an average of 2.65 ± 0.98 for training session one and 2.21 ± 0.62 for training session two. There was no effect of rearing experience on the success of passing either training session.

Of the chicks that passed the training criteria and were tested at 15 days of age, a chi-squared test indicates there was a significant difference in the proportion of chicks that made no choice in the control rearing group (35%) compared to the enriched rearing group (6.6%) in the first RFT when required to cross the marker lines ($\chi^2(1, n=35)= 3.902$, $p=0.048$). There was no difference between the ages or treatments in the second test to cross the marker lines or when required to go behind the screen to make a choice. Chicks that did not make a choice were removed from further analysis as this had no effect on results.

For the first test phase, of the chicks that made a choice, chicks at 14-15 days of age took longer to cross the marker lines and choose a screen (54.43 ± 50.23) compared to 28-29 days (29.50 ± 38.44 ; $z = -2.024$, $n = 66$, $p = 0.043$). There was no effect of treatment. The latency to go behind a screen was not affected by age or treatment. 65.2% of successful chicks used intra-maze cues when crossing the marker lines. Similarly, 76.3% of successful chicks used intra-maze cues when required to go and look behind a screen. These differences were not attributed to age or treatment.

For the second test phase there was no difference in latency to cross the marker line or go behind a screen between age or treatment. It was found that 57.4% of the successful chicks were relying on extra-maze cues when crossing the marker line, and 57.1% when going behind a screen. There was no significant difference between the use of extra or intra-maze cues for age or treatment.

Comparing the difference in use of intra-maze cues, of the chicks that made a choice, between the first and second test showed a significant difference in the use between the first (76.3%) and second test (42.9%). Looking at treatment effects, 75% of the control chicks made the same choice in test 1 and test 2, whilst only 50% of the treatment chicks made the same choice (Figure 8). However, this difference was not significant (see table 1 for summary of results).

Table 1 location

Table 1. A summary of the RFT results.

Test	Proportion of chicks	Test Statistic
Test 1 Cross marker lines	0.65 intra-cues	0.50, $p = 0.019^*$
Test 1 Behind screen	0.76 intra-cues	0.50, $p = 0.001^*$
Test 2 Cross marker lines	0.43 intra-cues	0.50, $p = 0.275$
Test 2 Behind screen	0.43 intra-cues	0.50, $p = 0.568$
Comparing use of intra-maze cues for test 1 and test 2 to cross marker lines.	0.43 intra-cues	0.65, $p = 0.005^*$
Comparing intra-maze cues for test 1 and test 2 behind screen.	0.43 intra-cues	0.76, $p = 0.038^*$
Comparing choice by control chicks for test 1 and test 2	0.75 same choice	0.50, $p = 0.077$

Figure 8 location

5 Discussion

Using a battery of tests allowed more of an overview of the effects of providing accessible elevated structures than has previously been obtained. We found high use of simple structures from a young age, with a greatly increasing ability and preference to use higher perches as birds aged. We

obtained different results from the three navigational tests. Chicks reared in a complex three-dimensional environment were faster at completing the detour test and more enriched chicks made a choice at 15 days of age in the RFT but there was no difference between the rearing groups in performance in the jump test.

The strong correlation between age and structure use corroborates previous studies showing an increase in structure use over time. Kozak et al. (2016) reared chicks in complex aviaries with low level platforms, perches and ramps finding a peak in elevated structure use around two weeks of age. Heikkila et al. (2006) observed all chicks in their study using perches by 22 days of age but the first chicks were observed on perches by 8 days of age. Our results show that access ramps and lower level structures up to 10cm were utilised in the first few days of age. Providing lower and more varied elevated structures may encompass the ability of all chicks and from a younger age, as seen in our study. Simply by adding an elevated ramp leading up to 25cm high perches we may provide access to all chicks by 10 days of age.

The chicks reared with elevated structures had shorter latencies to complete the detour test. This might suggest improved spatial cognition. However, there was no difference between treatments in the number of orientation errors or the successful completion of the test within 5 minutes. Given the difference in the latencies between the rearing groups, it was unexpected that an equal number of chicks from each group did not complete the detour test. One explanation for this is that some of the chicks might have been satisfied with being able to see the companion chicks through the mesh as the chicks would have had auditory and visual contact, this may not have differed with the rearing treatments. Faster completion of the detour test could be an indicator of improved spatial cognition, but it could also be a measure of motivation if chicks reared with elevated structures were more motivated to regain contact with pen mates. Speed of decision making has shown to correlate highly with other measures of motivation. Browne et al. (2010) tested chickens in a T-maze to ascertain their preferences for environments. Chickens with strongest preferences for an environment also had the shortest latencies to choose. Although only studied in adult laying hens, synchronous perching may be one possible reason why chicks reared with elevated structures may have had a stronger motivation to regain access to their companions. Synchronous perching at night may have strengthened affiliative bonds or reduced aggression (Eklund and Jensen, 2011, Donaldson and O'Connell, 2012). However, if the treatment chicks were highly motivated to regain access to their companions, we would expect to see significant differences in the latencies reflected in all three tests. There was no difference in the latency to reach companions in the RFT or the jump test, suggesting no difference in motivation between the rearing groups.

More orientation errors were made by older chicks, although latency and completion of the detour test within 5 minutes were not different between the age groups. Impulsivity is found to reduce over 7 to 19 days of age when chicks were trained to peck green or blue beads for a food reward (Amita and Matsushima, 2011). In our study it may be the case that younger chicks were more impulsive and made quick simple decisions based on strong imprinting. Errors may increase as older birds take account of more information, acquired with experience.

There was an interesting effect of age on direction taken when leaving the starting box. Evidence has shown there is increased activity in the right hemisphere of the brain at 10 and 11 days of age but by 15 days of age there is no specific hemispheric learning, suggesting both hemispheres are used equally (Rogers, 2014). In this study at 14-15 days of age 62.5% of chicks went right out of the detour box when facing their companions and viewed from above but when tested at 28-29 days of age 62.9% of the chicks went left out of the detour box. Studies have shown that domestic chicks tend to have a left bias in their environment. When tested on ordinality 5 day old chicks were more successful at locating the correct order when tested from left to right (Rugani et al., 2007). Similarly Regolin (2006) found 9 day old chicks will peck more to the left, suggesting an asymmetry that may be found in the bird brain. Vallortigara et al. (1999) tested chicks in a detour test at 4 days old with either the left or right eye covered or with binocular vision. They found that binocular chicks tended to detour to the left side of the barrier suggesting they use the right eye (chicks will turn their head to look forwards and walk in the direction their beak is facing), therefore the left hemisphere of the brain. In our study at 14-15 days more chicks appeared to be using the right hemisphere of the brain, whereas at 28-29 days of age more chicks were using the left hemisphere of the brain. This may indicate that changes in hemispheric dominance may be sustained for longer than 15 days of age. There is no research looking at the interactions between behaviour and brain lateralisation beyond 15 days of age so further work is needed to explore this.

In the Jump test, older chicks (28-29 days) were more successful than the younger birds (14-15 days) at accessing both levels of the test. Unlike Gunnarsson et al. (2000) we found no rearing treatment effect, although our control group had never had experience with raised structures. However, our procedures differed. Gunnarsson et al. (2000) compared birds reared with or without perches to 8 weeks of age and conducted the jump test at 16 weeks. We tested birds at a much younger age, so differences may have been minimised, with the control chicks only experiencing four weeks without elevated structures. Gunnarsson et al. (2000) also provided higher perches up to 120cm, our maximum height was 60cm, again minimising differences between our groups. The results of the jump test did demonstrate the challenge for 14-15-day old chicks to access a platform 20cm from the ground level as only 31% were successful at jumping to this first level regardless of the rearing

treatment. This is important to consider when rearing chicks commercially and we have demonstrated in this study that chicks will access raised structures if given the opportunity via lower level access ramps or perches.

The rotated floor test did not reveal any difference between rearing treatments in the success of meeting the training criterion. Despite testing only chicks that had passed the training criterion, a significantly smaller percentage of enriched chicks (6.6%) at 14-15 days of age failed to make a choice by crossing the marker lines compared to the control chicks when cues were confounded.

For chicks that successfully completed the tests, there was no treatment effect in use of intra or extra-maze cues during the two test sessions. Previous studies have found that chicks with experience of visual occlusion between days 10 to 12 tend to use distal or extra-maze cues in the test phase of the RFT, whereas chicks without such experience tend to use intra-maze cues (Freire and Rogers, 2005, Freire and Rogers, 2007, Wichman et al., 2009). We expected that access to elevated structures might provide incidental experience of visual occlusion and therefore that our treatment chicks would show a greater tendency to use extra-maze cues than our controls, but this was not the case. In the first RFT, the majority of our successful chicks from both rearing groups (76.3%) used intra-maze cues. It is possible that the elevated structures did not in fact provide chicks with sufficient experience of visual occlusion to have influenced their initial cue preference. One point to mention is that the previous studies that use the RFT rotate the entire arena. In contrast in our study only the screens were swapped. Therefore, in our case the markings on the wall of the arena would provide extra-maze cues, whereas in previous studies these would provide intra-maze cues. There are therefore stronger extra-maze cues in our study compared to the cited studies (Freire and Rogers, 2005, Freire and Rogers, 2007, Wichman et al., 2009). Our finding that the chicks used mainly intra-maze cues with this approach suggests even more strongly that they were not using extra-maze cues.

In the second RFT we found that many chicks reversed their cue preference, with 57.1% using extra-maze cues, and a larger shift in preference observed in the treatment chicks ($p=0.07$). All chicks may have shifted their cue use preference because tests (companions absent) were non-rewarded.

Chicks will therefore have experienced their initial test response as incorrect, possibly leading to a devaluation of the reliance initially placed on intra-maze cues and a shift in cue-use even after an intervening re-training schedule. Under short intervals of retention, specifically concerning objects and location, information is retained in both hemispheres of the brain (Regolin et al., 2005), possibly accounting for the shift in the cue use preference we observed in the second test. Wichman et al. (2009) and Freire and Rogers (2007) also interspersed training sessions with repeated non-rewarded

tests, but they did not explore whether chicks shifted cue use across the repeated tests, so we cannot compare our results. The increased tendency of treatment chicks to shift cue use may be because their experience of elevated structures provided them with a greater capacity to attend to cues of both types. Further exploration of the cue preferences and reversal learning capacities of chicks reared with and without elevated structures would be useful.

5.1 Conclusion

In other studies, we (Norman et al., 2018) and others (Gunnarsson et al., 2000) have found that early experience of structures such as ramps improves the use of the structures compared to birds that have had no experience, illustrating the importance of early life experiences. However, in these previous studies chicks were reared for a longer time (up to 8 weeks or more) under different rearing conditions. In contrast, the work presented here found that rearing with elevated structures up to 28-29 days of age had only subtle effects. There was a shorter latency in the detour test which might indicate improved spatial cognition or altered social motivation, although differences in the rearing groups' motivation was not reflected through all three tests. We found a tendency for treatment chicks to show a greater shift towards the use of extra-maze cues in repeated RFT. However, the battery of tests used did not reveal any substantial general effects on physical ability, social motivation or spatial cognition. It appears that age and development over time may have a stronger influence on spatial navigation and physical ability than short-term early experience of elevated structures.

6 Acknowledgements

We thank Stonegate for funding this study and providing the chicks.

7 Declarations of interest

Declarations of interest: none

8 References

- AMITA, H. & MATSUSHIMA, T. 2011. *Instantaneous and cumulative influences of competition on impulsive choices in domestic chicks. Frontiers in Neuroscience, 5.*
- APPLEBY, M. C., MAGUIRE, S. N. & MCRAE, H. E. 1986. *NESTING AND FLOOR LAYING BY DOMESTIC HENS IN A COMMERCIAL FLOCK. British Poultry Science, 27, 75-82.*
- BROWNE, W. J., CAPLEN, G., EDGAR, J., WILSON, L. R. & NICOL, C. J. 2010. *Consistency, transitivity and inter-relationships between measures of choice in environmental preference tests with chickens. Behavioural Processes, 83, 72-78.*
- CAMPBELL, D. L. M., DE HAAS, E. N. & LEE, C. 2018. *A review of environmental enrichment for laying hens during rearing in relation to their behavioral and physiological development. Poultry science.*

- CASEY-TROTT, T. M., GUERIN, M. T., SANDILANDS, V., TORREY, S. & WIDOWSKI, T. M. 2017. Rearing system affects prevalence of keel-bone damage in laying hens: a longitudinal study of four consecutive flocks. *Poultry Science*, 96, 2029-2039.
- DONALDSON, C. J. & O'CONNELL, N. E. 2012. The influence of access to aerial perches on fearfulness, social behaviour and production parameters in free-range laying hens. *Applied Animal Behaviour Science*, 142, 51-60.
- EFSA 2015. *Scientific Opinion on welfare aspects of the use of perches for laying hens*. EFSA Journal.
- EKLUND, B. & JENSEN, P. 2011. Domestication effects on behavioural synchronization and individual distances in chickens (*Gallus gallus*). *Behavioural Processes*, 86, 250-256.
- FREIRE, R. & CHENG, H. W. 2004. Experience-dependent changes in the hippocampus of domestic chicks: a model for spatial memory. *European Journal of Neuroscience*, 20, 1065-1068.
- FREIRE, R., CHENG, H. W. & NICOL, C. J. 2004. Development of spatial memory in occlusion-experienced domestic chicks. *Animal Behaviour*, 67, 141-150.
- FREIRE, R. & ROGERS, L. J. 2005. Experience-induced modulation of the use of spatial information in the domestic chick. *Animal Behaviour*, 69, 1093-1100.
- FREIRE, R. & ROGERS, L. J. 2007. Experience during a period of right hemispheric dominance alters attention to spatial information in the domestic chick. *Animal Behaviour*, 74, 413-418.
- GUNNARSSON, S., KEELING, L. J. & SVEDBERG, J. 1999. Effect of rearing factors on the prevalence of floor eggs, cloacal cannibalism and feather pecking in commercial flocks of loose housed laying hens. *British Poultry Science*, 40, 12-18.
- GUNNARSSON, S., YNGVESSON, J., KEELING, L. J. & FORKMAN, B. 2000. Rearing without early access to perches impairs the spatial skills of laying hens. *Applied Animal Behaviour Science*, 67, 217-228.
- HEIKKILA, M., WICHMAN, A., GUNNARSSON, S. & VALROS, A. 2006. Development of perching behaviour in chicks reared in enriched environment. *Applied Animal Behaviour Science*, 99, 145-156.
- JANCZAK, A. M. & RIBER, A. B. 2015. Review of rearing-related factors affecting the welfare of laying hens. *Poultry Science*, 94, 1454-1469.
- KEMPERMANN, G., KUHN, H. G. & GAGE, F. H. 1997. More hippocampal neurons in adult mice living in an enriched environment. *Nature*, 386, 493-495.
- KOBAYASHI, S., OHASHI, Y. & ANDO, S. 2002. Effects of enriched environments with different durations and starting times on learning capacity during aging in rats assessed by a refined procedure of the Hebb-Williams maze task. *Journal of Neuroscience Research*, 70, 340-346.
- KOZAK, M., TOBALSKE, B., MARTINS, C., BOWLEY, S., WUERBEL, H. & HARLANDER-MATAUSCHEK, A. 2016. Use of space by domestic chicks housed in complex aviaries. *Applied Animal Behaviour Science*, 181, 115-121.
- LAMBTON, S. L., KNOWLES, T. G., YORKE, C. & NICOL, C. J. 2010. The risk factors affecting the development of gentle and severe feather pecking in loose housed laying hens. *Applied Animal Behaviour Science*, 123, 32-42.
- LAMBTON, S. L., NICOL, C. J., FRIEL, M., MAIN, D. C. J., MCKINSTRY, J. L., SHERWIN, C. M., WALTON, J. & WEEKS, C. A. 2013. A bespoke management package can reduce levels of injurious pecking in loose-housed laying hen flocks. *Veterinary Record*, 172, 423-+.
- NICOL, C. J., BESTMAN, M., GILANI, A. M., DE HAAS, E. N., DE JONG, I. C., LAMBTON, S., WAGENAAR, J. P., WEEKS, C. A. & RODENBURG, T. B. 2013. The prevention and control of feather pecking: application to commercial systems. *Worlds Poultry Science Journal*, 69, 775-788.
- NORDQUIST, R. E., HEERKENS, J. L. T., RODENBURG, T. B., BOKS, S., ELLEN, E. D. & VAN DER STAAY, F. J. 2011. Laying hens selected for low mortality: Behaviour in tests of fearfulness, anxiety and cognition. *Applied Animal Behaviour Science*, 131, 110-122.
- NORMAN, K. I., WEEKS, C. A., PETTERSSON, I. C. & NICOL, C. J. 2018. The effect of experience of ramps at rear on the subsequent ability of layer pullets to negotiate a ramp transition. *Applied Animal Behaviour Science*, 208, 92-99.

- PETTERSSON, I. C., WEEKS, C. A., NORMAN, K. I. & NICOL, C. J. 2017. The ability of laying pullets to negotiate two ramp designs as measured by bird preference and behaviour. *Peerj*, 5.
- REGOLIN, L. 2006. The case of the line-bisection: When both humans and chickens wander left. *Cortex*, 42, 101-103.
- REGOLIN, L., GARZOTTO, B., RUGANI, R., PAGNI, P. & VALLORTIGARA, G. 2005. Working memory in the chick: parallel and lateralized mechanisms for encoding of object- and position-specific information. *Behavioural Brain Research*, 157, 1-9.
- ROGERS, L. J. 2014. *Asymmetry of Brain and Behavior in Animals: Its Development, Function, and Human Relevance*. *Genesis*, 52, 555-571.
- RSPCA 2016. *RSPCA Welfare Standards for Pullets (Laying hens)*.
- RUGANI, R., REGOLIN, L. & VALLORTIGARA, G. 2007. Rudimental numerical competence in 5-day-old domestic chicks (*Gallus gallus*): Identification of ordinal position. *Journal of Experimental Psychology-Animal Behavior Processes*, 33, 21-31.
- SNEDDON, I. A., BEATTIE, V. E., DUNNE, L. & NEIL, W. 2000. The effect of environmental enrichment on learning in pigs. *Animal Welfare*, 9, 373-383.
- TAHAMTANI, F. M., NORDGREEN, J., NORDQUIST, R. E. & JANCZAK, A. M. 2015. Early Life in a Barren Environment Adversely Affects Spatial Cognition in Laying Hens (*Gallus gallus domesticus*). *Frontiers in veterinary science*, 2, 3-3.
- VALLORTIGARA, G., REGOLIN, L. & PAGNI, P. 1999. Detour behaviour, imprinting and visual lateralization in the domestic chick. *Brain research. Cognitive brain research*, 7, 307-20.
- WICHMAN, A., HEIKKILA, M., VALROS, A., FORKMAN, B. & KEELING, L. J. 2007. Perching behaviour in chickens and its relation to spatial ability. *Applied Animal Behaviour Science*, 105, 165-179.
- WICHMAN, A., ROGERS, L. J. & FREIRE, R. 2009. Visual lateralization and development of spatial and social spacing behaviour of chicks (*Gallus gallus domesticus*). *Behavioural Processes*, 81, 14-19.
- WILKINS, L. J., MCKINSTRY, J. L., AVERY, N. C., KNOWLES, T. G., BROWN, S. N., TARLTON, J. & NICOL, C. J. 2011. Influence of housing system and design on bone strength and keel bone fractures in laying hens. *Veterinary Record*, 169, 414-U47.
- WILKINS, L. J., POPE, S., LEEB, C., GLEN, E., PHILLIPS, A., ZIMMERMAN, P., NICOL, C. & BROWN, S. N. 2005. Fracture rate in laying-strain hens at the end of the rearing period and the end of the laying period. *Animal Science Papers and Reports*, 23, 189-194.
- WORKMAN, L. & ANDREW, R. J. 1989. SIMULTANEOUS CHANGES IN BEHAVIOR AND IN LATERALIZATION DURING THE DEVELOPMENT OF MALE AND FEMALE DOMESTIC CHICKS. *Animal Behaviour*, 38, 596-605.

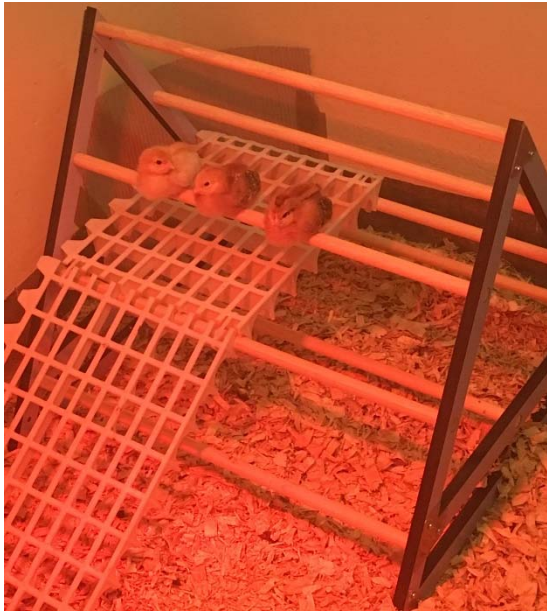

Figure 1. Enrichment structure comprising 8 wooden perches, a plastic platform and a ramp.

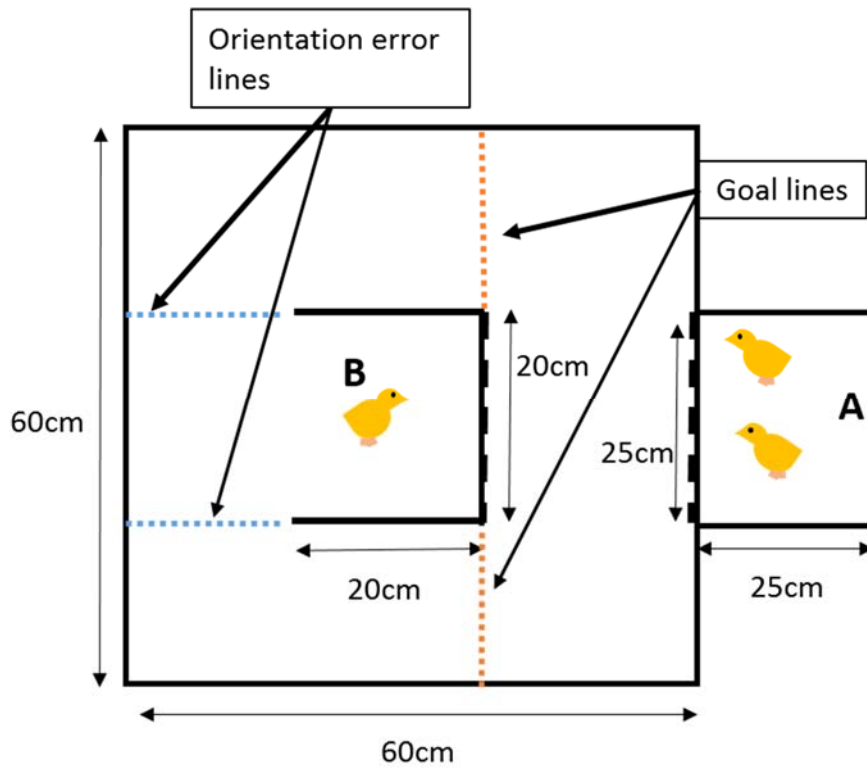

Figure 2. The detour test: The apparatus was made from cardboard. Point A shows the holding compartment and point B shows the detour compartment. The dotted lines on the holding compartment and detour compartment indicate the mesh viewing windows. Orientation error lines and goal lines are labelled.

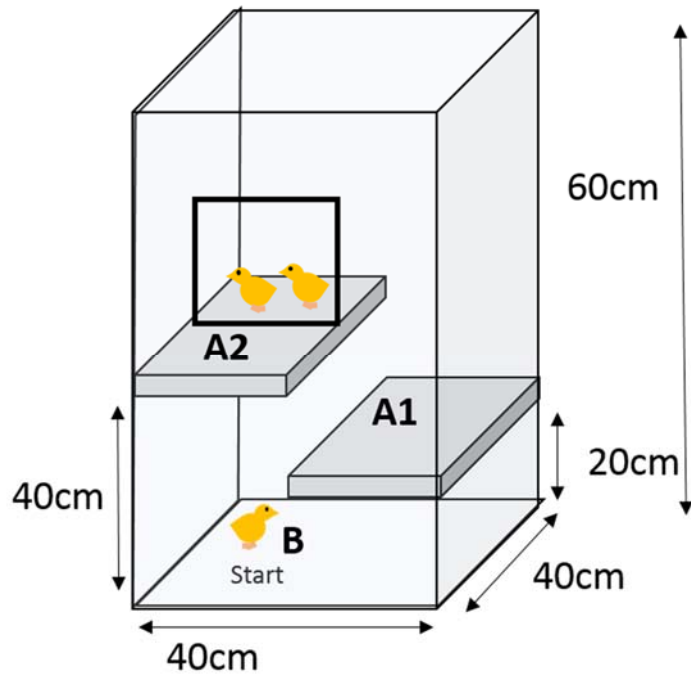

Figure 3. The Jump test: The three solid sides and the platforms were made from MDF. The front side was made from removable mesh. Point A1 shows where the companion birds were placed within a small compartment on the lower platform, and point A2 where they were placed on the upper platform. Point B shows the start position of the test chick.

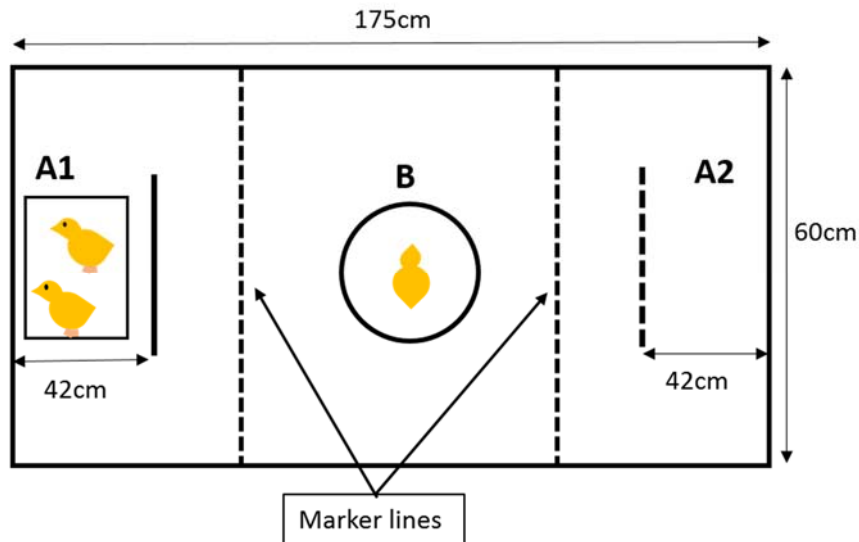

Figure 4. The rotated floor test: The arena was made from cardboard and the holding compartments were made from mesh. Points A1 and A2 indicate possible positions of the companion holding compartment behind the screens. Point B shows the position of the test chick within the observation compartment. The marker lines are labelled showing the point a chick had to cross to indicate its first choice.

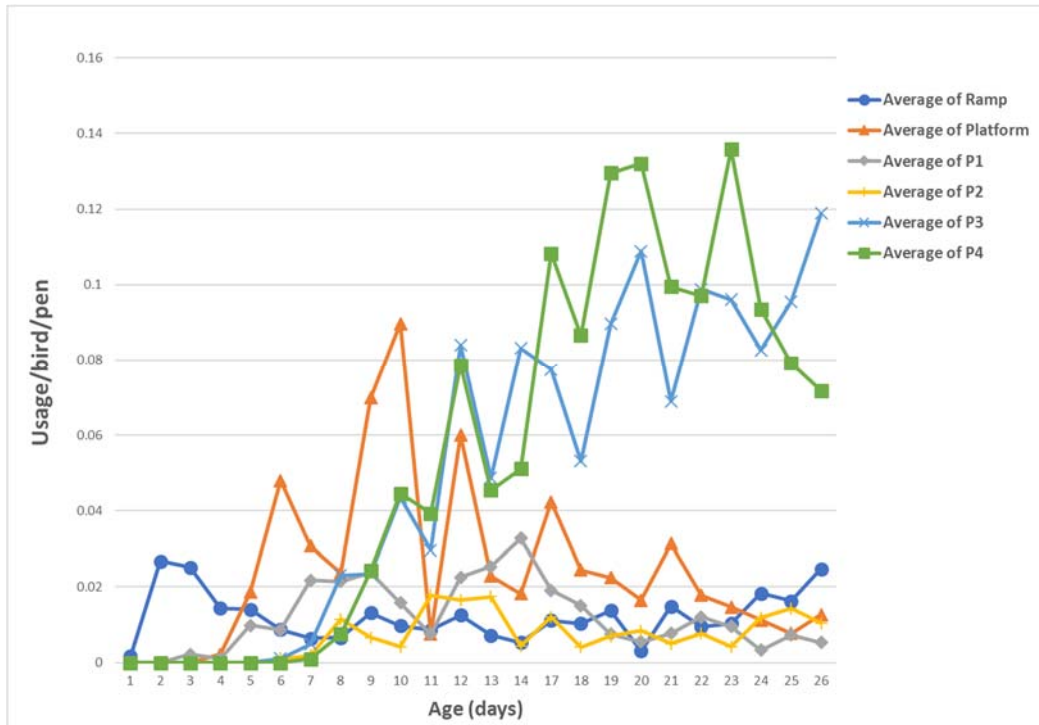

Figure 5. The mean usage of structures/bird/pen observed over time.

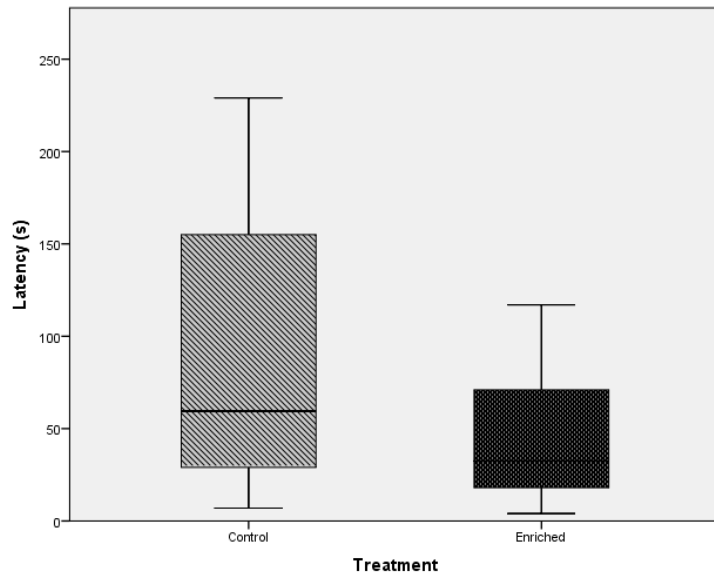

Figure 6. Box plot showing the difference in latency between the control and enriched group for the detour test.

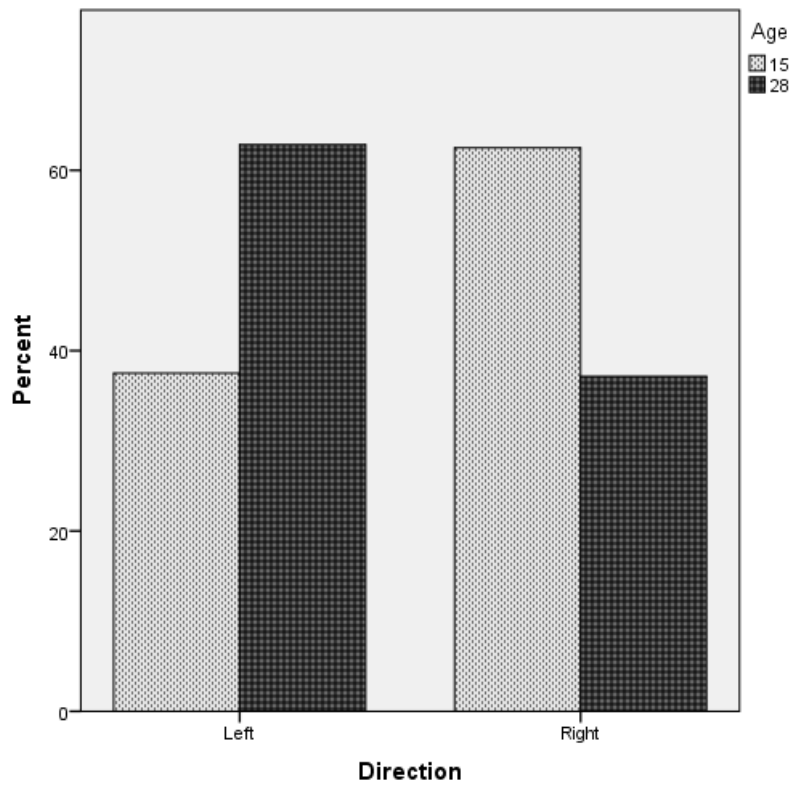

Figure 7. Direction of choice for successful chicks, separated by age groups.

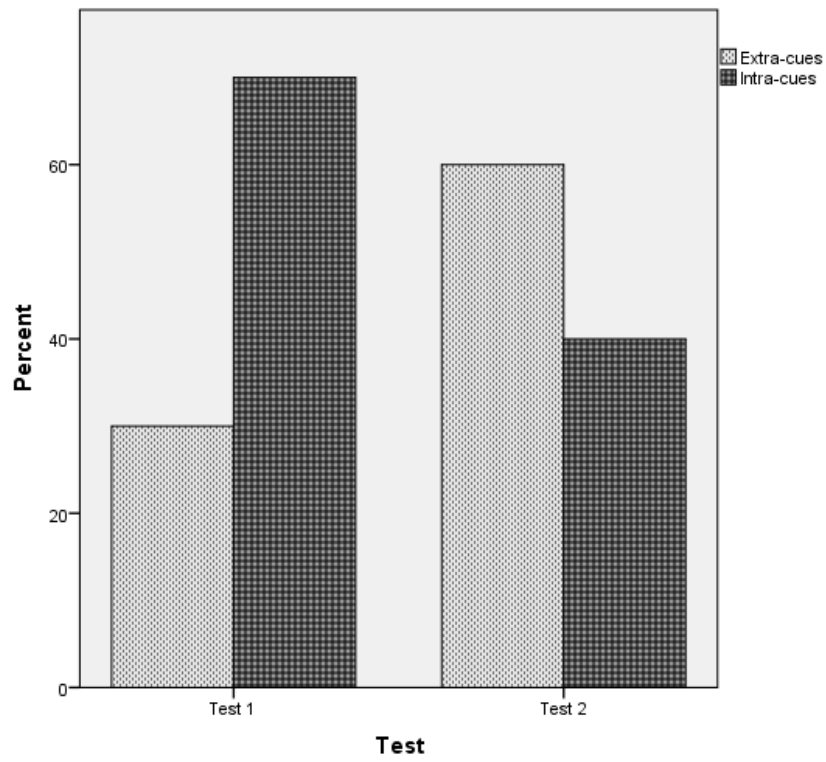

Figure 8. Graph showing the difference between test one and test two in the use of internal or external cues.