



Swales, SC., Beach, MA., Edwards, DJ., & McGeehan, JP. (1990). The performance enhancement of multibeam adaptive base-station antennas for cellular land mobile radio systems. *IEEE Transactions on Vehicular Technology*, 39(1), 56 - 67. <https://doi.org/10.1109/25.54956>

Peer reviewed version

Link to published version (if available):
[10.1109/25.54956](https://doi.org/10.1109/25.54956)

[Link to publication record on the Bristol Research Portal](#)
PDF-document

University of Bristol – Bristol Research Portal

General rights

This document is made available in accordance with publisher policies. Please cite only the published version using the reference above. Full terms of use are available:
<http://www.bristol.ac.uk/red/research-policy/pure/user-guides/brp-terms/>

The Performance Enhancement of Multibeam Adaptive Base-Station Antennas for Cellular Land Mobile Radio Systems

SIMON C. SWALES, MARK A. BEACH, DAVID J. EDWARDS, AND
JOSEPH P. MCGEEHAN, MEMBER, IEEE

Abstract—The problem of meeting the proliferating demands for mobile telephony within the confinements of the limited radio spectrum allocated to these services is addressed. A multiple beam adaptive base-station antenna is proposed as a major system component in an attempt to solve this problem. This novel approach is demonstrated here by employing an antenna array capable of resolving the angular distribution of the mobile users as seen at the base-station site, and then using this information to direct beams toward either lone mobiles, or groupings of mobiles, for both transmit and receive modes of operation. The energy associated with each mobile is thus confined within the addressed volume, greatly reducing the amount of co-channel interference experienced from and by neighboring co-channel cells. In order to ascertain the benefits of such an antenna, a theoretical approach is adopted which models the conventional and proposed antenna systems in a typical mobile radio environment. For a given performance criterion, this indicates that a significant increase in the spectral efficiency, or capacity, of the network is obtainable with the proposed adaptive base-station antenna.

I. INTRODUCTION

THE FREQUENCY SPECTRUM is, and always will be, a finite and scarce resource, thus there is a fundamental limit on the number of radio channels that can be made available to mobile telephony. Hence, it is essential that cellular land mobile radio (LMR) networks utilize the radio spectrum allocated to this facility efficiently, so that a service can be offered to as large a subscriber community as possible. Indeed, a major consideration of the second generation cellular discussions in both the US and Europe has focused on this point. However, present and proposed future generation cellular communication networks which employ either omnidirectional, or broad sector-beam, base-station antennas, will be beset with the problem of severe spectral congestion as the subscriber community continues to expand.

A measure often used to assess the efficiency of spectrum utilization is the number of voice channels per megahertz of available bandwidth per square kilometer [1]. This defines the amount of traffic that can be carried and is directly related to the ultimate capacity of the network. Hence, as traffic demands increase, the spectral efficiency of the network must also increase if the quality and availability of service is not to be degraded. At present this is overcome in areas with a

high traffic density by employing a technique known as *cell splitting*. However, the continuing growth in traffic demands has meant that cell sizes have had to be reduced to a practical minimum in many city centers in order to maintain the quality of service. As well as increasing the infrastructure costs, the number of subscribers able to access these systems simultaneously is still well below the long-term service forecasts due to the reduced *trunking efficiency* of the network. This places great emphasis on maximizing the spectral efficiency, or ultimate capacity, of future generation systems, and thereby fulfilling the earlier promises of performance. There have already been significant developments in terms of spectral efficient modulation schemes, e.g., the proposed US narrow-band digital linear system [2], [3] and the second generation Pan-European cellular network [4]. Also, in the area of antenna technology, the use of fixed coverage directional antennas has been considered [5]. In particular, the use of fixed phased array antennas, with carefully controlled amplitude tapers and sidelobe levels for the enhanced UK TACS network (ETACS) [6], are currently under evaluation. However, the application of *adaptive antenna arrays* in civil land mobile radio systems has hitherto received little attention, in spite of the significant advances made in this field for both military and satellite communications.

In this paper a multiple beam adaptive base-station antenna is proposed to complement other solutions, such as spectrum efficient modulation, currently being developed to meet the proliferating demands for enhanced capacity in cellular networks. The feasibility of such a scheme is demonstrated, and a comparison made with existing conventional antennas in a realistic mobile radio environment. Geometrical and statistical propagation models are used and a unique insight is given into the benefits of utilizing adaptive base-station antennas in a cellular radio system. Finally, the concept of such a scheme is discussed and the integration of adaptive antenna array technology into a mobile communications environment considered.

II. ADAPTIVE ANTENNA ARRAYS

An adaptive antenna array may be defined as one that modifies its radiation pattern, frequency response, or other parameters, by means of internal feedback control while the antenna system is operating. The basic operation is usually described in terms of a receiving system steering a *null*, that is, a reduction in sensitivity in a certain angular position, toward a

Manuscript received April 18, 1989. This work was supported by UK SERC.

The authors are with the Centre for Communications Research, Faculty of Engineering, University of Bristol, Bristol, B58 1TR, UK.
IEEE Log Number 9034227.

source of interference. The first practical implementation of electronically steering a null in the direction of an unwanted signal, a jammer, was the Howells–Applebaum sidelobe canceller for radar. This work started in the late 1950's, and a fully developed system for suppressing five jammers was reported in open literature in 1976 by Applebaum [7]. At about the same time Widrow [8] independently developed an approach for controlling an adaptive array using a recursive least squares minimization technique, now known as the LMS algorithm. Following the pioneering work of Howells, Applebaum, and Widrow, there has been a considerable amount of research activity in the field of adaptive antenna arrays, particularly for reducing the jamming vulnerability of military communication systems. However, to date, there has been little attention to the application of such techniques in the area of civil land mobile radio.

Adaptive antenna arrays cannot simply be integrated into any arbitrary communication system, since a control process has to be implemented which exploits some property of either the wanted, or interfering, signals. In general, adaptive antennas adjust their directional beam patterns so as to maximize the signal-to-noise ratio at the output of the receiver. Applications have included the development of receiving systems for acquiring desired signals in the presence of strong jamming, a technique known as *power inversion* [9]. Systems have also been developed for the reception of frequency hopping signals [10], [11], TDMA satellite channels [12] and spread spectrum signals [13]. Of particular interest for cellular schemes is the development of adaptive antenna arrays and signal processing techniques for the reception of multiple wanted signals [14].

A. Fundamentals of Operation

The adaptive array consists of a number of antenna elements, not necessarily identical, coupled together via some form of amplitude control and phase shifting network to form a single output. The amplitude and phase control can be regarded as a set of *complex weights*, as illustrated in Fig. 1. If the effects of receiver noise and mutual coupling are ignored, the operation of an N element uniformly spaced linear array can be explained as follows. Consider a wavefront generated by a narrow-band source of wavelength λ arriving at an N element array from a direction θ_k off the array boresight. Now taking the first element in the array as the phase reference and letting d equal the array spacing, the relative phase shift of the received signal at the n th element can be expressed as

$$\Psi_{nk} = \frac{2\pi d(n-1)}{\lambda} \sin \theta_k. \quad (1)$$

Assuming constant envelope modulation of the source at θ_k , the signal at the output of each of the antenna elements can be expressed as

$$x_{nk}(t) = e^{j(\omega t + \Psi_{nk})} \quad (2)$$

and the total array output in direction θ_k as

$$y_k(t) = \sum_{n=1}^N w_n e^{j(\omega t + \Psi_{nk})} \quad (3)$$

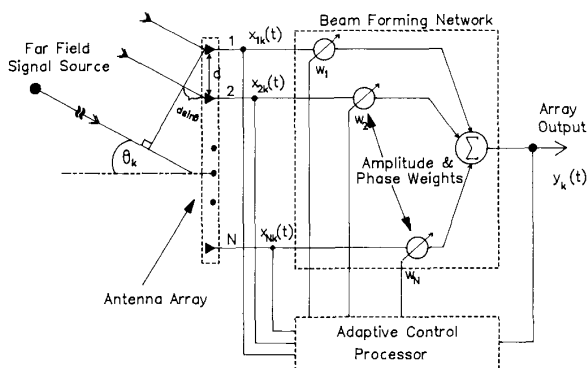

Fig. 1. An adaptive antenna array.

where w_n represents the value of the complex weight applied to the output of the n th element. Thus by suitable choice of weights, the array will accept a wanted signal from direction θ_1 and steer nulls toward interference sources located at θ_k , for $k \neq 1$. Likewise, the weighting network can be optimized to steer beams (a radiation pattern maxima of finite width) in a specific direction, or directions. It can be shown [15] that an N element array has $N - 1$ degrees of freedom giving up to $N - 1$ independent pattern nulls. If the weights are controlled by a feedback loop which is designed to maximize the signal-to-noise ratio at the array output, the system can be regarded as an *adaptive spatial filter*.

The antenna elements can be arranged in various geometries, with uniform line, circular and planar arrays being very common. The circular array geometry is of particular interest here since beams can be steered through 360° , thus giving complete coverage from a central base-station. The elements are typically sited $\lambda/2$ apart, where λ is the wavelength of the received signal. Spacing of greater than $\lambda/2$ improves the spatial resolution of the array, however, the formation of grating lobes (secondary maxima) can also result. These are generally regarded as undesirable.

B. Adaptive Antenna Arrays for Cellular Base-Station

Multiple beam adaptive antenna arrays have been considered by Davies *et al.* [16] for enhancing the number of simultaneous users accessing future generation cellular networks. It is suggested that each mobile is tracked in azimuth by a narrow beam for both mobile-to-base and base-to-mobile transmissions, as shown in Fig. 2. The directive nature of the beams ensures that in a given system the mean interference power experienced by any one user, due to other active mobiles, would be much less than that experienced using conventional wide coverage base-station antennas. It has already been stressed that high capacity cellular networks are designed to be interference limited, so the adaptive antenna would considerably increase the potential user capacity.

This increase in system capacity of the new base-station antenna architecture was evaluated [17] by considering the spatial filtering properties of an antenna array. The results show that this type of base-station antenna could increase the spectral efficiency of the network by a factor of 30 or more. These results were obtained for a hypothetical fast frequency hopping

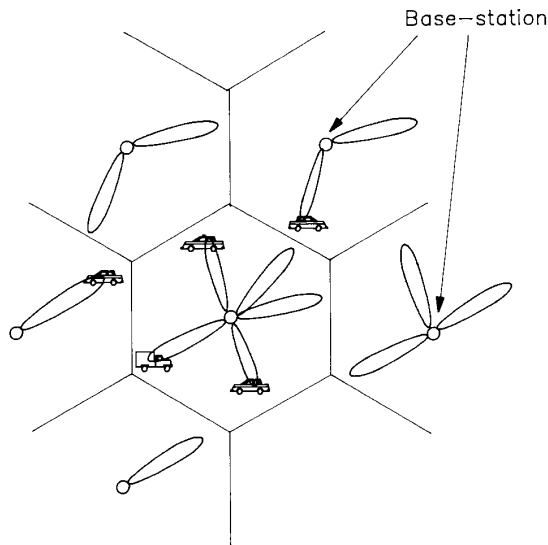

Fig. 2. Tracking of mobiles with multiple beams.

code division multiple access cellular network [18], assuming uniform user distribution and complete frequency reuse for the omnidirectional antenna case, i.e., adjacent cells are co-channel cells. Complete frequency reuse is then assumed for each of the beams formed by the adaptive array, i.e., adjacent beams are co-channel beams. Further, it was shown that a similar enhancement of efficiency can be obtained for either an idealized multibeam antenna, or a realizable 128 element circular array [19].

It was recognized in the analysis, but not fully assessed, that this approach would greatly increase the level of co-channel interference. It was, therefore, suggested that this problem could be overcome using dynamic channel allocation to eliminate the so called *common zones*. This again introduces additional hand-offs, reducing the trunking efficiency and available capacity of the network, as the mobile circumnavigates the cell.

The only study previous to the work discussed above considering the use of an adaptive antenna array in land mobile radio was by Marcus and Das [20] in 1983. The analysis assumed that the base-station, or repeater, sites could be placed closer together if an antenna array formed 20 dB nulls toward co-channel sites. This effectively reduces the amount of co-channel interference at the output of the base-station as explained in Section II. It was suggested that in this system the beam steering information could be derived from the squelch tone injection which is presently used in the US FM land mobile radio.

In contrast with the null steering technique considered by Marcus and Das, here the ability of the adaptive array to steer radiation pattern maxima toward the mobiles is considered. In the limit it can be envisaged that individual beams will be formed towards each mobile as illustrated in Fig. 2. It has already been mentioned that adaptive antenna technology cannot be simply integrated into an arbitrary communication system, and at present no one particular modulation scheme, or access technique, has been selected for the third generation of

cellular systems. However, some well-established trends are becoming apparent in the quest toward higher spectrally efficient modulation schemes [1] for the systems of the year 2000 and beyond. It is thus vital during the initial stages of research to develop antenna architectures which are, in essence, modulation scheme independent, so that a figure of merit can be obtained for the multibeam base-station antenna.

III. REDUCTION OF CO-CHANNEL INTERFERENCE USING ADAPTIVE ANTENNAS

In this paper the integration of an idealized adaptive array into an existing cellular network is considered. In order to ascertain the benefits of this class of antenna system compared with that of conventional omnidirectional base-station antenna systems, the following network topology has been assumed.

- 1) A cellular network consisting of hexagonal cells, with channel reuse every C cells (C is the cluster size).
- 2) The base-station transmitters are centrally located within each hexagonal cell.
- 3) There is a *uniform distribution* of users per cell.
- 4) There is a *blocking probability* of B in all cells.
- 5) The omnidirectional base-station antenna has an ideal beam pattern, giving a uniform circular coverage.
- 6) The adaptive base-station antenna can generate any number, m , of ideal beams, with a beamwidth of $2\pi/m$, and a gain equal to the omni-antenna.
- 7) Each adaptive beam will only carry the channels that are assigned to the mobiles within its coverage area.
- 8) Any mobile (or group of mobiles) can be tracked by the adaptive base-station antenna.
- 9) The necessary base-station hardware is available to enable beamforming and tracking.
- 10) The same modulation scheme can be used with each antenna system.

The blocking probability of B in assumption 4) is the fraction of attempted calls that cannot be allocated a channel. If there are " a " Erlangs of traffic intensity offered, the actual traffic carried is equal to $a(1 - B)$ Erlangs. The Erlang is a measure of traffic intensity, and measures the quantity of traffic on a channel or group of channels per unit time. This gives an *outgoing channel usage efficiency* (or loading factor) [21] of

$$\eta = a(1 - B)/N \quad (4)$$

where N is the total number of channels allocated per cell.

Assumptions 6), 7), and 8) imply the deployment of a somewhat hypothetical adaptive antenna system. This approach can be justified since a uniform user population has been assumed for both categories of antenna system. It is recognized that the dynamic, nonuniform, user distribution will have a significant effect on the results presented here. This will be considered in a subsequent more rigorous study. Also, in the analysis which follows only the base-to-mobile link has been studied, however, it can be shown that the analysis is also valid for the mobile-to-base link.

Two different categories of co-channel interference models are used as the basis for the study presented here. The first is the geometrical model adopted by Lee [5], followed by a more rigorous statistical analysis [21]–[23].

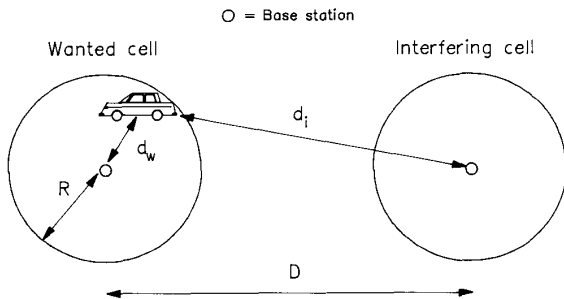

Fig. 3. Two co-channel cells.

IV. GEOMETRICAL PROPAGATION MODEL

This approach considers the relative geometry of the transmitter and receiver locations, and takes into account the propagation path loss associated with the mobile radio channel.

A. One Co-Channel Cell

Consider one co-channel cell which forms part of a cellular network as shown in Fig. 3. By definition both the cells have the same channel allocation, and a reuse distance of D separating the base-station transmitters. The *co-channel reuse ratio* is defined as

$$Q = D/R. \quad (5)$$

This ratio has also been termed the *co-channel interference reduction factor* [5] since the larger it is (i.e., the further apart the cells) the less the co-channel interference for a given modulation scheme. The level of acceptable co-channel interference governs the value of this parameter and the overall spectral efficiency of the network.

The area mean signal level experienced at the mobile is assumed to be inversely proportional to the distance from the base-station raised to a power γ . With the advent of smaller cells, the propagation path loss is close to the free-space value [24], however, it is envisaged that the proposed base-station will initially operate in larger cells. Therefore, as a starting point for the comparison to follow, the commonly used approximation that the received signal power is inversely proportional to the fourth power of range will be used [25]. Hence, the area mean signal level (in volts) received from the wanted base-station at a mobile a distance d_w from the transmitter is

$$m_w = k/d_w^2. \quad (6)$$

Similarly, the area mean signal level from the interfering base-station transmitter at a distance d_i is

$$m_i = k/d_i^2 \quad (7)$$

assuming in each case identical radiated transmitter powers and signal propagation constants, as denoted by the constant k .

Co-channel interference will occur when the ratio of the received wanted signal envelope, s_w , to the interfering signal envelope, s_i , is less than some *protection ratio*, p_r , i.e.:

$$s_w \leq p_r s_i. \quad (8)$$

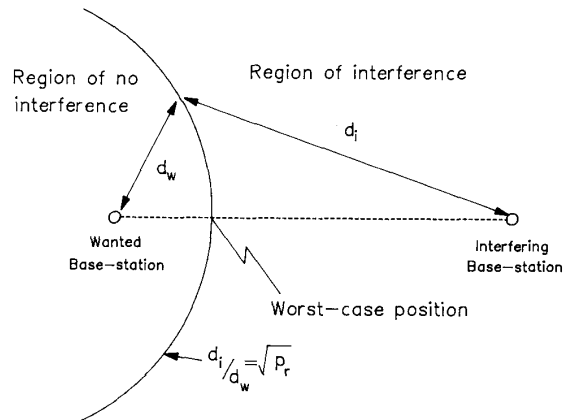

Fig. 4. Contour defining interference regions.

The protection ratio is defined by the modulation scheme employed [1]. Considering only the propagation path loss, the received signal envelopes are equal to the area mean signal levels, hence:

$$\frac{s_w}{s_i} = \frac{m_w}{m_i} = \frac{d_i^2}{d_w^2} \leq p_r. \quad (9)$$

So, for a given protection ratio, a locus given by

$$d_i/d_w = \sqrt{p_r} \quad (10)$$

can be drawn. This defines a region where no interference will occur, and where it will always occur, as illustrated in Fig. 4. For the worst-case position, which is in a direct line between the transmitters as shown, the co-channel reuse ratio is

$$Q = D/R = 1 + d_i/d_w = 1 + \sqrt{p_r}. \quad (11)$$

For a given protection ratio and modulation scheme, this defines the minimum spacing between co-channel cells in order to avoid interference, and the maximum spectral efficiency obtainable.

In this discussion it is assumed that the same modulation scheme is employed for both antenna systems under evaluation. This implies that the protection ratio and reuse distances are identical in both cases. Therefore, there would appear to be no apparent benefit from employing adaptive antenna technology at the base-station site. However, the occurrence of co-channel interference is a statistical phenomena. Hence, when comparing omni- and adaptive antennas, it is necessary to introduce the concept of the *probability of co-channel interference* occurring, i.e., $P(s_w \leq p_r s_i)$. This is often called the *outage probability*, which is the probability of failing to obtain satisfactory reception at the mobile in the presence of interference.

If the cells are considered to be identical, i.e., have equal blocking probabilities, then on average, there will be $N\eta$ active channels in each cell (η is as defined in (4)). So, in the case of the omnidirectional antenna, given that the wanted mobile is already allocated a channel, the probability of that channel being active in an interfering cell is the required outage

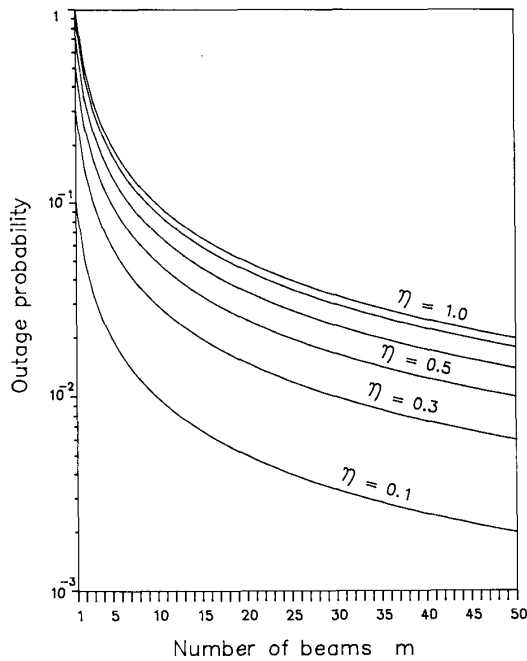

Fig. 5. Outage as a function of the number of beams.

probability. Hence, when the wanted mobile is in the region of co-channel interference the outage probability is given by

$$P(s_w \leq p_r s_i) = \frac{\text{number of active channels}}{\text{total number of channels}} = \frac{N\eta}{N} = \eta. \quad (12)$$

Now consider the case of the adaptive antenna as previously described, with m beams per base-station providing coverage of the whole cell, and with $N\eta/m$ channels per beam, given a uniform distribution of users. The same regions of co-channel interference can be defined, however, when the wanted mobile is within the region where co-channel interference may occur, the outage probability is reduced. The wanted mobile is always covered by at least one beam from the co-channel cell, hence, the outage probability is equal to the probability that one of the channels in the aligned beam is the corresponding active co-channel¹ and is given by

$$P(s_w \leq p_r s_i) = \frac{\text{number channels per beam}}{\text{total number of channels}} = \frac{N\eta/m}{N} = \frac{\eta}{m} \quad (13)$$

where the omniscase is given by $m = 1$. These results are presented graphically in Fig. 5, and show the strong influence of the number of beams, m , on the outage probability. The influence of the loading factor, η , is as expected, i.e., the less the loading, the fewer the number of active channels, and hence, a reduced chance of co-channel interference. This assumes that there are still m beams formed even though there are only

¹ The "active co-channel" is the channel that has also been allocated to the wanted mobile.

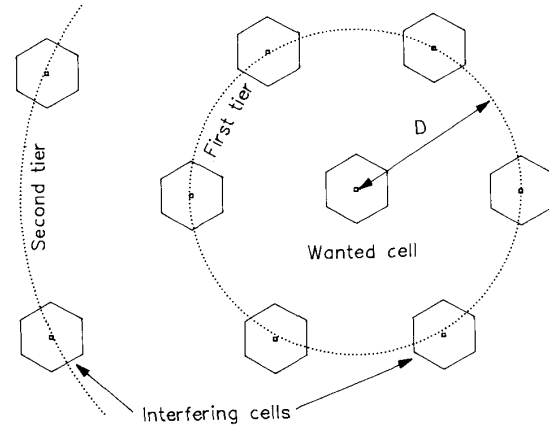

Fig. 6. Hexagonal cellular layout showing tiers of interferers.

$a(1 - B)$ active channels (or users). This is only really valid if $a(1 - B) > m$ and that the users are uniformly distributed within the cell. If this were not the case, and the number of beams formed was less than m , the outage probability would be reduced even further since the wanted mobile will not be covered by a co-channel beam all the time. This situation will not be pursued further since this analysis can be regarded as *worst-case* situation.

B. Six Co-Channel Cells

The previous approach can now be simply extended to assess the effect of six co-channel interferers, i.e., the first tier of co-channel cells in a conventional cellular scheme as shown in Fig. 6. It is considered that further tiers of interferers will not significantly affect the results except when reuse distances become small. Equation (9) can now be rewritten for this more realistic representation of the cellular network

$$\frac{s_w}{s_I} = \frac{m_w}{m_I} = \frac{d_w^{-2}}{\sum_{i=1}^n d_i^{-2}} \leq p_r \quad (14)$$

where the total mean signal level from the interfering cells, m_I , is the sum of the mean level from each active cell. Thus in a fully loaded system, the number of active users is six (i.e., $n = 6$). If all the d_i are assumed to be equal and the wanted mobile is at the edge of a cell boundary, as for the case described in Lee [5], then the co-channel reuse factor can be expressed as

$$Q = [6(s_w/s_I)]^{1/\gamma}. \quad (15)$$

Subjective tests showed that over a mobile radio channel $s_w/s_I \geq 18$ dB (i.e., $p_R = 18$ dB) gave good speech transmission for a 25-kHz FM channel operation. A value of Q can now be calculated to define the minimum cluster size, C . Using simple geometry it would be possible to evaluate the actual s_w/s_I in the worst-case locations. From this, a contour may be drawn defining regions with and without interference. For both classes of antenna systems the outage probability is still zero within the contour (i.e., when $s_w/s_I > p_r$), but outside,

in the region of interference:

$$P(s_w \leq p_r s_I) = \left(\frac{\eta}{m}\right)^6 \quad (16)$$

where s_I is the total co-channel interference and the omniscase is given by $m = 1$. Since it is assumed that all m beams per cell are formed, there are six beams aligned onto the wanted mobile at any time. The outage probability within the region of interference is then found by considering the probability that the active co-channel is in each of these beams.

C. Analysis of Results

The use of adaptive multiple beam-forming base-stations would, based upon the analysis presented so far, appear to give an improvement in performance with regard to the reduction of the probability of co-channel interference. The improvement depends on the degree of adaptivity used, i.e., the number of ideal beams formed. However, the above approach is over simplistic and gives a rather optimistic view of the situation. Firstly, the beams are assumed to be ideal, giving an equal gain over the whole beamwidth. In practice this would not be the case. Also, a hypothetical situation could be envisaged where, if m is large enough to satisfy a given outage criterion,² it would appear that the ultimate reuse distance ($D/R = 2$) is possible for any modulation scheme. Hence, adjacent cells are co-channel cells, the radius of which is decided by the required coverage area of the base-station site. In spite of this though, the analysis has been useful in introducing some of the important factors that affect the performance of a mobile radio network which exploits frequency reuse as a means of increasing spectral efficiency.

V. STATISTICAL PROPAGATION MODEL

In the previous analysis only the path loss associated with the mobile radio environment was considered when calculating the level of co-channel interference. This was useful in demonstrating the principle benefits to be offered by adaptive antennas, although it is an over simplified approach and totally unrealistic of many land mobile radio environments. It was shown that a single contour defining regions of operation where co-channel interference would occur can be drawn, however, it is known that the signal levels fluctuate rapidly generating small isolated pockets of interference in an operational system. In some adverse environments these areas may be quite close to the base-station antenna.

There is seldom a line of sight path between the base-station and the mobile, and hence, radio communication is obtained by means of diffraction and reflection of the transmitted energy. This produces a complicated signal pattern causing the field strength to vary greatly throughout the cell, and the received signal at the moving mobile to fluctuate very rapidly. This is generally attributed to the superposition of two different classifications of signal fading phenomenon: *fast fading* (or just fading) due to the multipath nature of the received signal, and *slow fading* (shadowing), the slower variations of

² If there are ten beams ($m = 10$) a 10% outage criterion could be satisfied in a fully loaded system (13).

the received signal due to variations in the local terrain. In areas experiencing this type of signal variation, the area mean signal level is essentially constant. In order to model these propagation effects, they are included in a statistical fashion, the fading and shadowing described above being represented by Rayleigh and log-normal type distributions, respectively.

A. One Co-Channel Cell

Various studies [26]–[28] have been undertaken to analyze co-channel interference originating from a single co-channel interfering cell in an attempt to characterize the mobile radio environment. In particular the rigorous analysis presented by French [22] has been adopted here. The fast fading is the rapid fluctuation of the signal level s about the local mean \bar{s} ($\bar{s} = \langle s \rangle$), and is usually described by a Rayleigh type probability density function (pdf), i.e.:

$$P(s/\bar{s}) = \frac{\pi s}{2\bar{s}^2} \exp\left[-\frac{\pi s^2}{4\bar{s}^2}\right]. \quad (17)$$

Shadowing of the radio signal due to the terrain, i.e., by buildings and hills, causes the local mean level \bar{s} to fluctuate about the area mean. It has been generally accepted that this variation is *log-normally* distributed about the area mean m_d , where $m_d = \langle \bar{s}_d \rangle$, the mean of \bar{s} in decibels. (Note, a subscript “ d ” indicates that a signal is in decibels.) The area mean level is approximately proportional to the inverse of the distance from the base-station raised to the power γ , as described in Section IV-A. Hence, the log-normal shadowing pdf is given by

$$P(\bar{s}_d) = \frac{1}{\sqrt{2\pi}\sigma} \exp\left[-\frac{(\bar{s}_d - m_d)^2}{2\sigma^2}\right]. \quad (18)$$

The *standard deviation*, σ , describes the degree of shadowing. This parameter typically varies from 6 to 12 dB in urban areas, the larger value being associated with very built up inner city areas.

The combined pdf can now be expressed as

$$P(s) = \int_{-\infty}^{\infty} P(s/\bar{s}) \cdot P(\bar{s}_d) d\bar{s}_d. \quad (19)$$

By substituting $\bar{s} = 10^{\bar{s}_d/20}$ (from $\bar{s}_d = 20 \log_{10} \bar{s}$) into (17), the combined pdf becomes

$$P(s) = \sqrt{\pi/8\sigma^2} \int_{-\infty}^{\infty} \frac{s}{10^{\bar{s}_d/20}} \exp\left[\frac{\pi s^2}{4 \times 10^{\bar{s}_d/20}}\right] \cdot \exp\left[-\frac{(\bar{s}_d - m_d)^2}{2\sigma^2}\right] d\bar{s}_d. \quad (20)$$

1) *Outage Probability With Fading and Shadowing*: The outage probability with fading and shadowing is derived in French [22] and the resulting integral is

$$P(s_w \leq p_r s_I) = \frac{1}{\sqrt{\pi}} \int_{-\infty}^{\infty} \frac{\exp(-u^2)}{1 + 10^{(z_d - 2\sigma u)/10}} du \quad (21)$$

where, $z_d = m_{dw} - m_{di} - p_R$, $\sigma = \sigma_w = \sigma_i$, and u is an internal variable.

In many situations it is possible to greatly reduce the fading, e.g., antenna diversity at the mobile, and a similar result to that above can be derived [22] for shadowing only. Note that the result in (21) is for the case of the omnidirectional base-station antenna.

2) *Outage Probability with an Adaptive Antenna:* The outage probability for an adaptive antenna can be simply expressed as

$$P(s_w \leq p_r s_i, m) = P(s_w \leq p_r s_i) \cdot \left(\begin{array}{c} \text{probability of an active co-channel} \\ \text{in the aligned beam} \end{array} \right) \\ = P(s_w \leq p_r s_i) \cdot \left(\frac{\eta}{m} \right) \quad (22)$$

i.e., the probability that the ratio of the wanted signal to the interfering signal is less than some protection ratio (21) and the probability that the aligned beam actually contains the active channel (13). Again, the outage probability is reduced by a factor m . This is illustrated graphically in Fig. 7. The loading factor is fixed at 70% ($\eta = 0.7$) and the fading and shadowing case is considered for $\sigma = 6$ dB. This represents a typical urban environment. These results have been obtained by solving (21) and (22) numerically with $m = 1, 2, 4, 8, 16,$ and 32 . Note that $m = 1$ gives the omniscase.

The outage probability varies as expected with z_d and, for the omniscase is consistent with French. Note, however, that for a given z_d the outage is reduced by a factor of m when an adaptive antenna is considered.

3) *Calculation of the Reuse Distance:* When the fading and shadowing characteristics of the mobile radio channel are considered, it can be shown that no definite boundary exists between regions of interference, and regions of no interference. Co-channel interference can even occur close to the wanted transmitter if, for example, the wanted signals fades and the interfering signal peaks as illustrated in Fig. 8. Now, since co-channel interference is a statistical phenomena, it can be described by contours of outage probability. Using the definition for z_d and (9) yields

$$\frac{d_i}{d_w} = \sqrt{z p_r} = \sqrt{10^{(z_d + p_R)/20}}. \quad (23)$$

So for a given z_d , protection ratio p_R , and outage probability, contours can be drawn as shown in Fig. 9. If an adaptive antenna is used, the value of each contour is reduced by a factor of m , hence, for a given outage criterion, the service area is increased.

This can be represented graphically by substituting (23) into (11) and expressing the co-channel reuse ratio as

$$Q = 1 + \sqrt{10^{(z_d + p_R)/20}}. \quad (24)$$

From this formula the outage probability against the reuse ratio for a given protection ratio can be obtained in a manner similar to that of French.

4) *Calculation of the Cluster Size:* In a cellular network with a hexagonal layout, the cluster size is related to the reuse

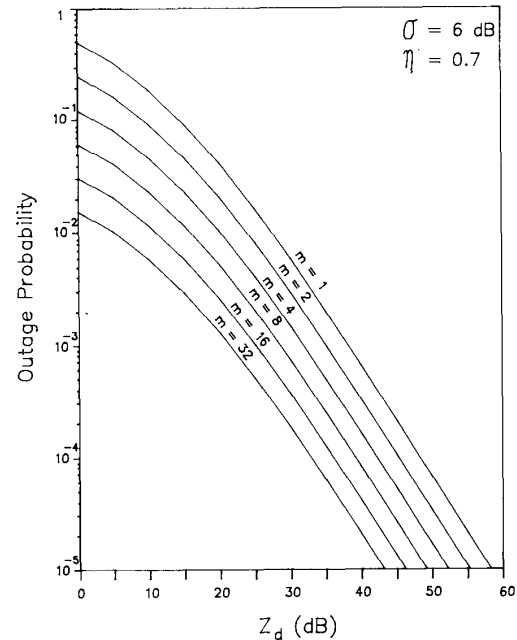

Fig. 7. Outage probability for one co-channel cell.

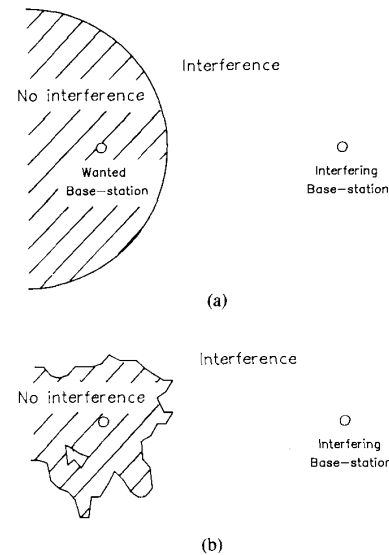

Fig. 8. Contour defining regions of interference. (a) With no shadowing or fading. (b) With shadowing and fading.

distance by

$$C = Q^2/3. \quad (25)$$

Note that only certain values of C are possible in a hexagonal cellular network [25], i.e., $C = (3, 4, 7, 9, 12, 13, 16, 19, 21, \dots)$. Using (24) this can be expressed as

$$C = 1/3[1 + \sqrt{10^{(z_d + p_R)/20}}]^2. \quad (26)$$

Again the outage probability can now be evaluated for various cluster sizes for a given protection ratio.

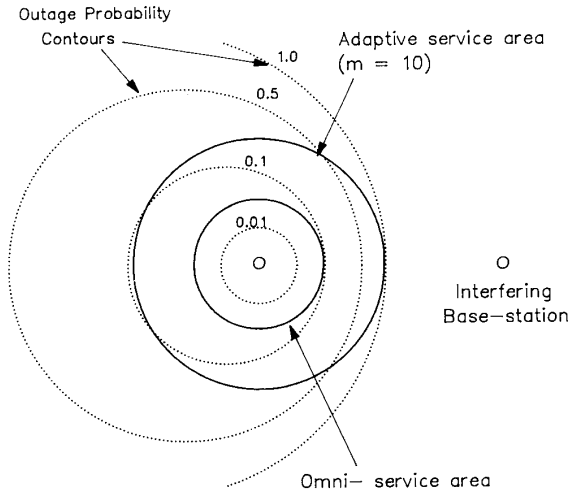

Fig. 9. Outage probability contours and service areas for a 10% chance of interference.

5) *Calculation of Spectral Efficiency*: To gain a more meaningful interpretation when comparing different system architectures in a cellular network, the spectral efficiencies [1] of the various schemes are usually considered. This gives an unbiased measure of spectrum utilization, and is usually expressed as the number of channels/MHz of bandwidth/km², i.e.,

$$\text{efficiency, } E = \frac{B_t/B_c}{B_t(CA)} = \frac{1}{B_c CA} \quad (27)$$

where

- B_t total available bandwidth,
- B_c channel spacing in megahertz,
- C number of cells per cluster,
- A cell area (km²).

To enable a simple comparison to be made between omnidirectional and adaptive antenna systems, it is necessary to assume that an identical modulation scheme will be employed in both cases. Thus $E \propto 1/C$, and the relative spectral efficiency can be expressed as

$$\frac{E_{\text{adapt}}}{E_{\text{omni}}} = \frac{C_{\text{omni}}}{C_{\text{adapt}}} \quad (28)$$

Equation (22) was solved numerically and then the cluster size C , given by (26), was calculated for a fading and shadowing (6 dB variation) environment with a loading factor of 0.7. An outage criterion of 1% is used and, although this value is quite low, it serves to give some idea of the advantages that can be obtained by using this new class of base-station antenna. Two values of protection ratio, 8 and 20 dB, are considered in order to cover a variety of modulation schemes [1]. Then, using (28), the relationship between the relative spectral efficiencies was calculated for $m = 1, 2, 4, 8, 16$, and 32, and is shown in Fig. 11.

B. Six Co-Channel Cells

In order to present a more realistic comparison between omnidirectional and adaptive base-station antennas, it is nec-

essary to consider interference originating from multiple co-channel cells. Several different studies [21], [29]–[31] have pursued this goal, but of particular interest is the work by Muammar and Gupta [23]. This has been adopted here since the analysis follows directly from the previous discussion. However, a few alterations have been necessary in order that a more meaningful comparison could be presented.

Fig. 6 shows the cellular layout of a mobile radio network for an arbitrary cell cluster size of C . It is recognized that there are many tiers of co-channel interferers present, but only the first, i.e., cells at a distance D from the wanted base-station, is considered here. This assumption was shown to be valid in similar studies [29], [31]. The wanted mobile in the central cell receives a signal envelope s_w from the wanted base-station. It also receives unwanted signals from the co-channel cells s_i , $i = 1, 2, \dots, n$, where n is the number of active interfering co-channel cells (the maximum number being six in this case). The total co-channel interference is thus given by

$$s_I = \sum_{i=1}^n s_i \quad (29)$$

When the wanted signal does not exceed this value by the protection ratio, co-channel interference will occur. In order to calculate the total probability of co-channel interference (or simply the outage probability), it is necessary to consider the probability of there being co-channel interference and n interfering co-channel cells. Using conditional probability theory this can be expressed as

$$P((\text{co-channel interference}) \cap (n \text{ active co-channels})) = P(s_w \leq p_r s_I/n) \cdot P(n) \quad (30)$$

$P(n)$ is the PDF of n and $P(s_w \leq p_r s_I/n)$ is the *conditional outage probability* (the probability of co-channel interference given that there are n active interfering cells). Hence, the total outage probability is given by

$$P(s_w \leq p_r s_I) = \sum_n P(s_w \leq p_r s_I/n) \cdot P(n) \quad (31)$$

since all possible values of n must be taken into account. Here only the first tier is considered, so the maximum number for n is six.

The pdf of the signal envelope s is as given by (20) and from here the conditional probability of co-channel interference for multiple interferers, when considering both fading and shadowing, can be derived. This result is simply quoted here without proof as details [23] can be found elsewhere.

$$P(s_w \leq p_r s_I/n) = \frac{1}{2\pi} \int_{-\infty}^{\infty} dX \int_{-\infty}^{\infty} \left[1 - \exp\left(-\frac{\pi}{4K^2(X, u)}\right) \right] \cdot \exp\left(-\frac{(X^2 + u^2)}{2}\right) du$$

where

$$20 \log_{10} K(X, u) = z_d + C \cdot \ln(4/\pi n^2) + \sigma X - \sigma_{NY} u - \frac{1}{4C} (\sigma_{NX}^2 - \sigma_{NY}^2) \quad (32)$$

and where σ_{NX}^2 and σ_{NY}^2 are defined by Muammar and Gupta [23]. The variable z_d is as defined previously, and u and X are internal variables. This integral can be solved using various numerical techniques and the results are presented later.

1) *PDF of n , $P(n)$* : $P(n)$ is the probability that the number of active interfering co-channel cells is n and so if the channels are assumed independent and identically distributed, this has the form of a binomial pdf:

$$P(n) = \binom{6}{n} p^n (1-p)^{6-n} \quad (33)$$

where p is the probability of finding *one* interfering co-channel active. Using the loading factor η , as defined before, the probability p that a single co-channel cell has an active co-channel, given that the wanted mobile has been assigned that channel already, is

$$p = \frac{\text{number of active channels}}{\text{total number of channels}} = \frac{a(1-B)}{N} = \eta. \quad (34)$$

The *origination probability* [21], or the probability that n co-channel interfering cells are using the same channel as the wanted mobile, can then be expressed as

$$P(n) = \binom{6}{n} \eta^n (1-\eta)^{6-n}. \quad (35)$$

Hence, giving the total outage probability as

$$P(s_w \leq p_r s_I) = \sum_n P(s_w \leq p_r s_I / n) \cdot \binom{6}{n} \eta^n (1-\eta)^{6-n}. \quad (36)$$

This can now be calculated for a given outgoing channel usage efficiency over the range of z_d . Alternatively, as before, the outage probability can be considered against the co-channel reuse ratio Q , or the cluster size C .

2) *Integration of Adaptive Antennas*: With an omnidirectional antenna the probability of an active interfering co-channel cell was given by η , the outgoing channel usage efficiency or cell loading factor. Since it is assumed that at any one time all m beams per cell are formed, there will always be six beams aligned onto the wanted mobile. Hence, for the adaptive antenna:

$$\begin{aligned} p &= \left(\begin{array}{l} \text{probability that the interfering co-channel is in the} \\ \text{beam pointing at the wanted mobile} \end{array} \right) \\ &= \frac{\text{number of active channels in beam}}{\text{total number of channels}} \\ &= \frac{a(1-B)/m}{N} = \frac{\eta}{m}. \end{aligned} \quad (37)$$

Hence, the *origination probability* is given by

$$P(n) = \binom{6}{n} \left(\frac{\eta}{m} \right)^n \left(1 - \frac{\eta}{m} \right)^{6-n}. \quad (38)$$

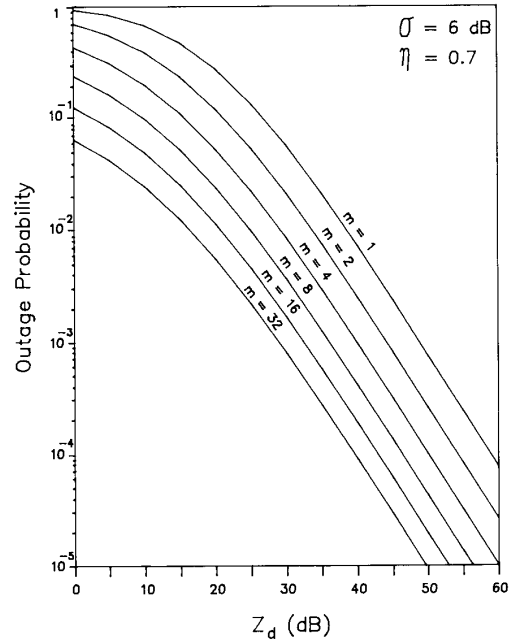

Fig. 10. Outage probability with six co-channel cells.

The overall outage probability can now be expressed as

$$P(s_w \leq p_r s_I, m) = \sum_n P(s_w \leq p_r s_I / n) \cdot \binom{6}{n} \left(\frac{\eta}{m} \right)^n \left(1 - \frac{\eta}{m} \right)^{6-n} \quad (39)$$

where the omnidirectional case is given for $m = 1$.

As before, when only one co-channel cell was considered, a comparison can now be made between the two base-station technologies. Fig. 10 shows the variation of the total outage probability against z_d . The case with both fading and shadowing is considered here, hence, the results are obtained by numerically solving (32) and applying (39) for $m = 1, 2, 4, 8, 16, \text{ and } 32$. From (26) and (28) the cluster size and the relative spectral efficiency can now be calculated for a given outage criterion (1%), and is shown in Fig. 11. An outgoing channel usage efficiency of 0.7 and a log-normal shadowing standard deviation of 6 dB has been assumed. Protection ratios of 8 and 20 dB have also been considered.

3) *Analysis of Results*: It can be seen from Fig. 11 that for a given outage criterion and modulation scheme, the introduction of an adaptive array capable of forming eight tracking beams, into an existing network, would produce at least a threefold increase in efficiency. This can be equated to be three times the number of channels per megahertz per square kilometer, or simply as three times as many users in each cell. This result has been obtained by considering the co-channel interference originating from single and multiple co-channel cells. The propagation model employed here considers both the fading and shadowing characteristics of the mobile channel.

Although the application of power control of the individual tracking beams has not been considered to date, this may

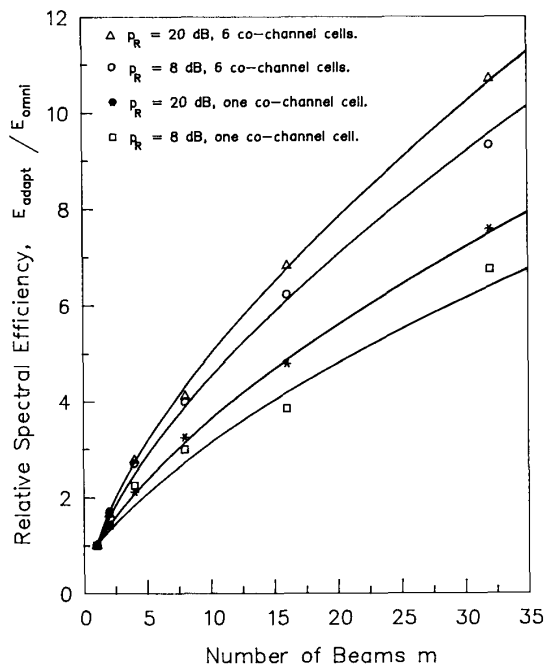

Fig. 11. Relative spectral efficiency as a function of the number of beams formed.

prove to be essential for future generation networks. It has been shown [21], [30] that base-station power control can substantially reduce co-channel interference for omnidirectional antenna systems. It can thus be envisaged that power control of the multiple beam adaptive base-station antenna would greatly reduce energy “overspill” into neighboring cells. The combination of the two adaptive techniques will be considered in a later study.

VI. THE “SMART” BASE-STATION ANTENNA

Adaptive antennas operate by exploiting some property of the signal environment present at the array aperture [7], [8], and it is due to this ability that they are often aptly referred to as “smart” arrays [32]. In the previous theoretical analysis it was assumed that the base-station antenna could track any mobile, or group of mobiles, within its coverage area. Therefore, on reception, the array must be capable of resolving the angular distribution of the users as they appear at the base-station site. Armed with this knowledge, the base-station is then in a position to form an optimal set of beams, confining the energy directed at a given mobile within a finite volume. This concept can be further illustrated by considering the sequence of events illustrated in Fig. 12. The scenario depicted is realistic of many operational systems where there are lone mobiles, or groups of mobiles, dispersed throughout the cell. Using the spatial distribution of the users acquired by the array on reception, the antenna system can dynamically assign single narrow beams to illuminate the lone mobiles, and broad beams to the numerous groupings along major highways. It can be seen that by constraining the energy transmitted toward the mobiles, there are directions in which little or no signal is radiated. It is this phenomenon which gives rise to

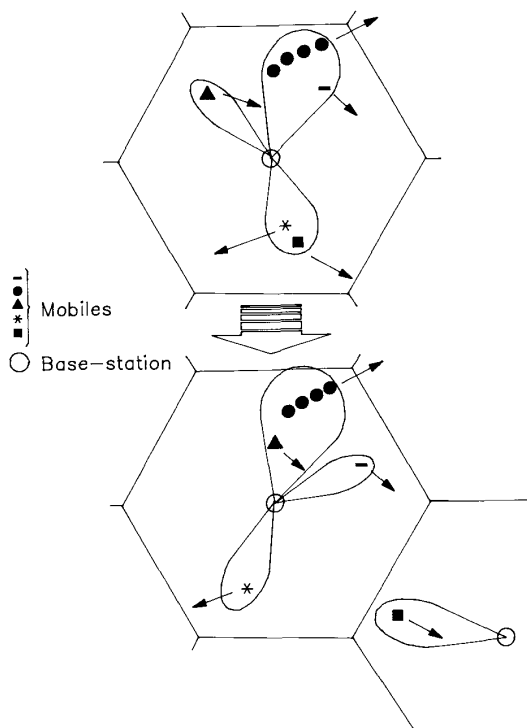

Fig. 12. Optimal beam forming.

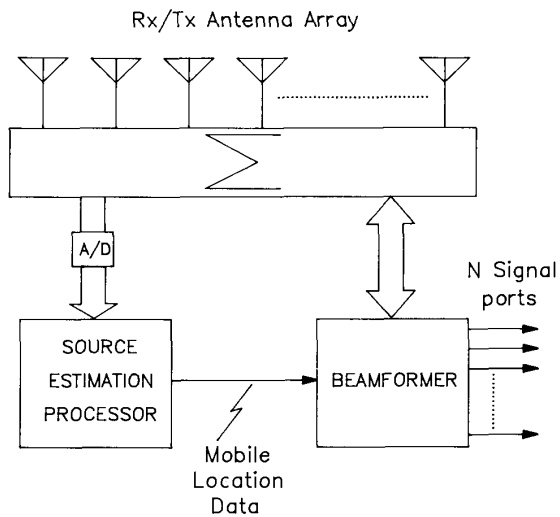

Fig. 13. The “smart” antenna.

the reduction in the probability of co-channel interference occurring in neighboring cells, and thereby increasing the spectral efficiency (or capacity) of the network as illustrated in the previous section.

The realization of such an adaptive base-station antenna requires an architecture capable of locating and tracking the mobiles, and a beam-forming network thus capable of producing the appropriate multiple independent beams. The former requirement can be broadly classified as that of a direction finding, or a spatial estimation problem. These two tasks are illustrated in Fig. 13 as a source estimation or direction find-

ing (DF) processor and a beamformer. In recent publications [33], [34] this concept was further extended to consider the implementation of such a base-station antenna. Also the results from some initial computer simulations were presented and these demonstrated the ability of the antenna array to resolve multiple mobile users in the signal fading conditions typical of the LMR scenario. Many of the popular *superresolution* DF algorithms used in radar were evaluated, and some beam-forming techniques which could generate the optimal beam set using the knowledge of the mobile distribution were discussed. Finally, a proposal was put forward for a fully adaptive base-station antenna test rig to demonstrate the principles of operation and show how such an antenna could be incorporated into the existing cellular network. The results of this work will form the basis for a future paper.

Intelligent antenna systems have also been considered for numerous other applications. Sandler and Kokar [35] have described the use of an adaptive antenna in conjunction with an artificial intelligence system as an antijamming antenna for radar. Here the antenna has a wealth of stored data which is used to "teach" the system about the various scenarios it will encounter. In this way it can adapt readily to every new situation as it is presented and "learn" from its mistakes. It is intended to exploit the synergy that exists between this application and that of the proposed cellular mobile radio base-station. Initially, the knowledge of the mobile locations within each cell could be utilized to provide an elegant hand-off mechanism as the mobiles cross cell boundaries. Also, combined with a knowledge of the local terrain and shadowing characteristics, it should be possible to extend this technique and provide a cellular network with dynamic cell boundaries. This would thus allow the optimal usage of the available system capacity.

VII. DISCUSSION

The full potential of adaptive antenna technology in the future generation of ubiquitous portable communication networks is yet to be realized. The goal is to be able to provide universal pocket sized communications by the year 2000. This implies that the system must make very efficient use of the radio spectrum if it is to be made available to a large consumer base; thus making the portable equipment relatively cheap. Also, it is highly desirable that the portable communicator has a long duty cycle between battery recharging implying power efficient modulation. The role of adaptive antennas has already been discussed in terms of the former requirement, however, it must be emphasized that spectrum efficient modulation is still a vital parameter in the design of these systems. The potential enhancement of power efficiency obtainable using spatial filtering has not been fully assessed to date, and the merits of this technique in a rural service area are of particular interest.

The study presented here has demonstrated the feasibility of an adaptive base-station antenna for cellular communications networks. A comparison made between the conventional and proposed schemes has shown that a marked improvement in spectral efficiency and capacity can be obtained, e.g., an idealized eight beam antenna could provide a threefold increase

in spectral efficiency. In addition to the other advantages that can be gained, as outlined in the previous section, the infrastructure costs incurred by this base-station antenna must also be considered. The majority of these costs are associated with the acquisition of the base-station site, construction of various buildings and antenna masts. When compared with existing schemes, such as cell splitting, the overall cost is less, since fewer base-station sites are required for an equivalent user capacity. Also, unlike the techniques of cell splitting and cell sectorization, the multiple beam adaptive array would not impair the trunking efficiency of the network.

ACKNOWLEDGMENT

We are extremely grateful to our colleagues at the Bristol University Centre for Communications Research for their stimulating intellectual support.

REFERENCES

- [1] H. Hammuda, J. P. McGeehan and A. Bateman, "Spectral efficiency of cellular land mobile radio systems," in *Proc. 38th IEEE Veh. Technol. Conf.*, Philadelphia, PA, pp. 616-622, June 15-17, 1988.
- [2] J. A. Tarallo and G. I. Zysman, "Modulation techniques for digital cellular systems," in *Proc. IEEE Vehicular Technology Conf.*, pp. 245-248, June 15-17, 1988.
- [3] J. Uddenfeldt, K. Raith and B. Hedberg, "Digital technologies in cellular radio," in *Proc. IEEE Vehicular Technology Conf.*, pp. 516-519, June 15-17, 1988.
- [4] F. Lindell, J. Swerup and J. Uddenfeldt, "Digital cellular radio for the future," *The Ericsson Rev.*, no. 3, 1987.
- [5] W. C. Y. Lee, "Elements of cellular mobile radio systems," *IEEE Trans. Veh. Technol.*, vol. VT-35, pp. 48-56, May 1986.
- [6] P. C. Carlier, "Antennas for cellular phones," *Commun. Int.*, pp. 43-46, Dec. 1987.
- [7] S. P. Applebaum, "Adaptive arrays," *IEEE Trans. Antennas Propagat.*, vol. AP-24, pp. 585-598, Sept. 1976.
- [8] B. Widrow, P. E. Mantey, L. J. Griffiths, and B. B. Goode, "Adaptive antenna systems," *Proc. IEEE*, vol. 55, pp. 2143-2159, Dec. 1967.
- [9] R. T. Compton, "The power inversion adaptive array: Concept and performance," *IEEE Trans. Aerospace Electron. Syst.*, vol. AES-15, pp. 803-814, 1979.
- [10] L. Acar and R. T. Compton, "The performance of LMS adaptive array with frequency hopped signals," *IEEE Trans. Aerospace Electron. Syst.*, vol. AES-21, pp. 360-370, May 1985.
- [11] K. Bakhrui and D. J. Torrieri, "The maximum algorithm for adaptive arrays and frequency-hopping communication," *IEEE Trans. Antennas Propagat.*, vol. AP-32, pp. 919-928, Sept. 1984.
- [12] R. T. Compton, R. J. Huff, W. G. Swarner, and A. A. Ksienski, "Adaptive arrays for communication systems: An overview of research at The Ohio State University," *IEEE Trans. Antennas Propagat.*, vol. AP-24, pp. 599-607, 1976.
- [13] R. T. Compton, "An adaptive antenna in a spread spectrum communication system," *Proc. IEEE*, vol. 66, pp. 289-298, Mar. 1978.
- [14] M. A. Beach, A. J. Copping, D. J. Edwards, and K. W. Yates, "An adaptive antenna for multiple signal sources," in *Proc. IEE Fifth Int. Conf. on Antennas and Propagation*, University of York, 1987.
- [15] J. E. Hudson, *Adaptive Array Principles*, IEE Electromagnetic Wave Series No. 11. Stevenage, U.K.: Peter Peregrinus, 1981.
- [16] Telecom Australia, "Base-station antennas for future cellular radio systems," *Rev. Activities 1985/1986*, pp. 41-43, 1985-1986.
- [17] W. S. Davies, R. J. Lang, and E. Vinnal, "The challenge of advanced base station antennas for future cellular mobile radio systems," presented at IEEE Int. Workshop on Digital Mobile Radio, Melbourne, Australia, Mar. 10, 1987.
- [18] G. R. Cooper and R. W. Nettleton, "A spread spectrum technique for high capacity mobile communications," *IEEE Trans. Veh. Technol.*, vol. VT-27, pp. 264-275, 1978.
- [19] D. H. Archer, "Lens-fed multiple beam arrays," *Microwave J.*, pp. 171-195, Sept. 1984.
- [20] M. J. Marcus and S. Das, "The potential use of adaptive antennas to increase land mobile frequency reuse," presented at *IEE 2nd Int. Conf. on Radio Spectrum Conservation Techniques*, CP224, Birmingham, UK, Sept. 6-8, 1983.

- [21] K. Daikoku and H. Ohdate, "Optimal channel reuse in cellular land mobile radio systems," *IEEE Trans. Veh. Technol.*, vol. VT-32, pp. 217-224, Aug. 1983.
- [22] R. C. French, "The effects of fading and shadowing on channel reuse in mobile radio," *IEEE Trans. Veh. Technol.*, vol. VT-28, pp. 171-181, Aug. 1979.
- [23] R. Muammar and S. Gupta, "Co-channel interference in high capacity mobile radio systems," *IEEE Trans. Commun.*, vol. COM-30, pp. 1973-1978, Aug. 1982.
- [24] J. H. Whiteker, "Measurements of path loss at 910 MHz for proposed microcell urban mobile systems," *IEEE Trans. Veh. Technol.*, vol. VT-37, pp. 125-129, Aug. 1989.
- [25] W. C. Jakes, *Microwave Mobile Communications*. New York: Wiley, 1974.
- [26] W. Gosling, "Protection ratio and economy of spectrum use in land mobile radio," *Proc. Inst. Elect. Eng.*, vol. 127, pt. F, pp. 174-178, June 1980.
- [27] M. Hata, K. Kinoshita, and K. Hirade, "Radio link design of cellular land mobile communication systems," *IEEE Trans. Veh. Technol.*, vol. VT-31, pp. 25-31, Feb. 1982.
- [28] A. G. Williamson, "Coverage, co-channel interference and outage probability calculations for mobile radio systems," in *Proc. IREE 20th Int. Electron. Convention and Exhibition*, Melbourne, pp. 224-227, Sept./Oct. 1985.
- [29] D. C. Cox, "Co-channel interference considerations in frequency reuse small-coverage-area radio systems," *IEEE Trans. Commun.*, vol. COM-30, pp. 135-142, Jan. 1982.
- [30] V. Palestini and V. Zingarelli, "Outage probability computation and cellular coverage for mobile radio," in *Proc. 37th IEEE Veh. Technol. Conf.*, Tampa Bay, FL, pp. 468-476, 1987.
- [31] Y. S. Yeh and S. C. Schwartz, "Outage probability in mobile telephony due to multiple log-normal interferers," *IEEE Trans. Commun.*, vol. COM-32, pp. 380-388, Apr. 1984.
- [32] W. F. Gabriel, "Adaptive arrays—An introduction," *Proc. IEEE*, vol. 64, pp. 239-272, Feb. 1976.
- [33] S. C. Swales, M. A. Beach, and D. J. Edwards, "Multi-beam adaptive base-station antennas for cellular land mobile radio systems," in *Proc. 39th IEEE Veh. Technol. Conf.*, San Francisco, CA, pp. 341-348, Apr. 29-May 3, 1989.
- [34] S. C. Swales, M. A. Beach, D. J. Edwards, and J. P. McGeehan, "A multi-beam adaptive base-station antenna for cellular land mobile radio systems," in *Proc. 1989 IEEE Workshop on Mobile and Cordless Telephone Communications*, University of London, UK, pp. 55-61, Sept. 25-26, 1989.
- [35] S. S. Sandler and M. Kokar, "Intelligent antennas," in *Proc. URSI Int. Symp. on Electromagnetic Theory*, Budapest, Hungary, pp. 159-161, 1986.

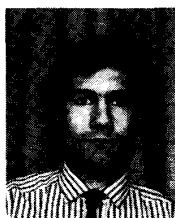

Simon C. Swales received the B.Eng. degree in electrical and electronic engineering from the University of Bristol, U.K., in 1987. He is currently engaged in postgraduate research at the University of Bristol, UK.

His research interests include the use of adaptive antennas arrays for future land mobile radio systems.

Mr. Swales is an Associate Member of the Institution of Electrical Engineers.



Mark A. Beach received the B.Sc. degree in electronic engineering from the University of York and the Ph.D. degree from the University of Bristol, UK, in 1983 and 1988, respectively.

He has worked for the Telecommunications Research Laboratories at the GEC Hirst Research Centre. He then joined the Department of Electrical and Electronic Engineering, University of Bristol, where he investigated various signal processing techniques for the control of adaptive antenna arrays operating in multiple signal source environments.

Currently, he is a Lecturer in communications at Bristol University. His research interests include the development of novel antenna systems for both terrestrial and satellite land mobile communications systems and RF circuit techniques.

Dr. Beach is an Associate Member of the Institution of Electrical Engineers.



David J. Edwards received the B.Sc. degree in physics, the M.Sc. degree in the physics of materials and the Ph.D. degree from Bristol University, in 1972, 1973, and 1987, respectively.

He worked at British Telecom for 11 years, where he was engaged in research on communications, antennas, measurement techniques and instrumentation systems. In 1985, he joined the Department of Electrical Engineering, Bristol University, where he conducted research in the areas of communications and microwave techniques. Currently, he is with the Department of Engineering Science, Oxford University.

Dr. Edwards was awarded the Institution of Electrical Engineers Prize for Innovation in 1989. He is a member of the Institution of Electrical Engineers and a Fellow of the Royal Astronomical Society.

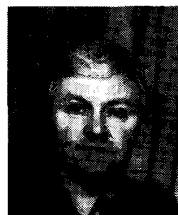

Joseph P. McGeehan (M'83) was born in Bootle, Merseyside, England, on February 15, 1946. He received the B.Eng. and Ph.D. degrees in electrical engineering from the University of Liverpool, England, in 1967 and 1972, respectively.

From 1970 to 1972 he held the position of Senior Scientist at the Allen Clark Research Centre, The Plessey Company Ltd., where he was primarily concerned with research into solid-state GaAs devices and their applications. In 1972 he was appointed Lecturer in Engineering at the University of Bath and promoted to Senior Lecturer in 1983, and led project teams conducting research into the application of signal processing techniques to linear modulation techniques for mobile radio communication systems and millimetric open waveguide techniques and systems. In 1985 he was appointed to the Chair of Communications Engineering in the Department of Electrical and Electronic Engineering at the University of Bristol and is Director of the Centre for Communications Research.

Dr. McGeehan is a member of the U.K. Study Group 8A of the International Radio Consultative Committee. He is the author of some 70 scientific papers. In recent years, he has served as a member of the U.K. Home Office (Directorate of Radio Technology) Working Group on comparative modulation techniques for mobile radio, was an advisor to the DTI Defence Spectrum Review Committee, and currently serves on a number of IEE Professional Committees.