



Webber, J.L., Beach, M.A., Allen, B., & Canagarajah, C.N. (2001).  
*Performance investigation of DS-CDMA detectors employing a dual polarised antenna.* 1518 - 1522.  
<https://doi.org/10.1109/VTC.2001.956451>

Peer reviewed version

Link to published version (if available):  
[10.1109/VTC.2001.956451](https://doi.org/10.1109/VTC.2001.956451)

[Link to publication record on the Bristol Research Portal](#)  
PDF-document

## University of Bristol – Bristol Research Portal

### General rights

This document is made available in accordance with publisher policies. Please cite only the published version using the reference above. Full terms of use are available:  
<http://www.bristol.ac.uk/red/research-policy/pure/user-guides/brp-terms/>

# Performance Investigation of DS-CDMA Detectors Employing a Dual Polarised Antenna

Julian Webber, Mark Beach, Ben Allen and Nishan Canagarajah  
Centre for Communications Research, University of Bristol,  
Queens Building, Bristol. BS8 1TR. UK. Email: julian.webber@bristol.ac.uk

**Abstract:** The benefits of polarisation diversity as a fade countermeasure within second generation cellular networks are well known. Capacity enhancement by means of joint detection is also a well-regarded technique for interference-limited systems such as TD-CDMA (Time Division – Code Division Multiple Access) within the UMTS (Universal Mobile Telecommunication System) wireless standards. However, relatively little attention has been focussed towards the potential gains of combining these two technologies. This paper considers, by means of a series of wideband dual polar channel measurements from a field trials campaign taken within the lower UMTS band (1910-1915 MHz), the relative merits of this approach when applied to a multistage interference canceller. This paper shows that signal strength improvements of between 2.5dB and 3.2dB at the 1% cumulative level were observed by applying dual polarised antennas at the receiver.

## 1. INTRODUCTION

The 3<sup>rd</sup> generation wireless communications systems in Europe and elsewhere employ Direct Sequence-Code Division Multiple Access (DS-CDMA) with either Time Division Duplex (TDD) mode or Frequency Division Duplex (FDD) mode as the wireless access method [1]. CDMA receivers conventionally employ a rake detector consisting of matched filters and these are prone to the “near-far” effect in a multiuser environment unless tight power control [2] is maintained and further, this solution is only optimal in the single user multipath scenario.

In indoor and urban areas the multipath energy is contained in a relatively short time window and polarisation diversity offers an additional diversity dimension. It is also expected that dual polarised antennas will be widely deployed outdoors in 3G systems, and it is proposed here to exploit this additional diversity in order to enhance the performance of indoor CDMA receivers. The optimum detector applies the Maximum Likelihood Sequence Estimation (MLSE) algorithm, though its complexity is exponential with the number of users and makes its current implementation impractical. Common sub-optimal adaptive detectors include the Linear Minimum Mean Square (LMMSE). Interference cancellers subtract estimates of Multiple Access Interference (MAI) noise to further improve performance. Polarisation Diversity (PD) has been discussed in recent

papers [3] but its research applied to 3<sup>rd</sup> generation receiver design is relatively new. A simulation of a dual polarised channel was used in a CDMA simulation in [4] where the cross correlation between branches was computer generated.

This paper is organised as follows: The principle of CDMA and the UMTS physical frame structure are described in section 2. The principles of polarisation diversity are described in section 3. In section 4 the wideband channel measuring equipment that was used to collect the channel data is detailed together with the indoor and outdoor to indoor measurement campaign. In sections 5 and 6, dual polar detectors are described and their performances are determined.

## 2. SYSTEM DESCRIPTION

Users in a CDMA system are assigned a unique code that is mutually orthogonal to other user codes, so that the received signal can be separated at the receiver, allowing the detection of the desired users data. In TD-CDMA a data symbol of bit rate  $1/T_b$ , is modulated by a short code (4, 8, or 16 chip lengths of chip period  $T_c$ ) consisting of  $T_b/T_c$  chips. The ratio  $T_b/T_c$  is termed the processing gain (PG) (which is equal to the number of chips per bit), and allows signals to be detected in the presence of a certain degree of Additive White Gaussian Noise (AWGN) and Multiple Access Interference (MAI) from other users. The small processing gain in TDD systems permit joint detection to be efficiently deployed as current DSPs can compute the reduced number of filter coefficient multiplications in real time.

A software simulation has been developed here based on the UMTS TD-CDMA system [5] and enables the performance enhancement of detectors to be assessed using measured channel responses. The physical channel ‘super-frame’ consists of 72 ‘radio-frames’ each of 10ms period [6] and, each radio-frame consists of 15 time slots (each of 667 $\mu$ s). Each time slot contains a midamble or training sequence that can be used to perform channel estimation for 8 users.

### 3. POLARISATION DIVERSITY

The physical dimensions to achieve sufficient spatial decorrelation can be quite cumbersome for TD-CDMA applications. Hence, space diversity is currently not widely deployed in indoor pico-cells. The frequency responses of the two orthogonal polarisations, recorded within the coherence time, hint at how dual polarised antennas can provide diversity gain from independently fading signals. The polarisation of an electromagnetic wave describes the orientation of the electric field vector with respect to time [7], and this is rotated each time it is reflected or refracted by the scattering environment (Fig. 2).

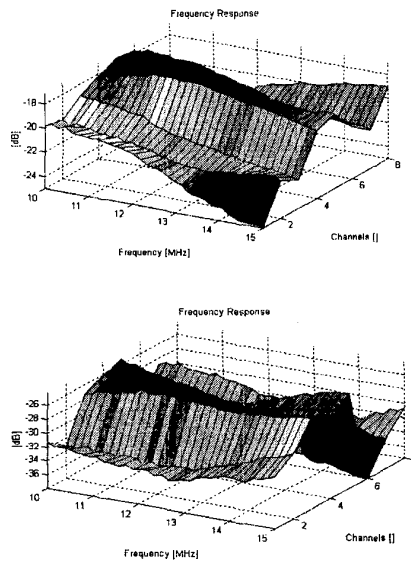

Fig. 1 - Frequency and spatial responses of an indoor environment on  $\pm 45^\circ$  polarisations

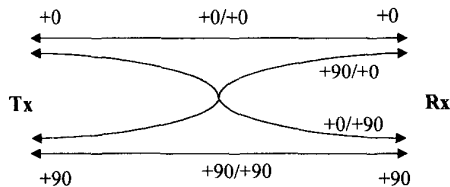

Fig. 2 - Cross coupling of polarised signals

### 4. INDOOR CHANNEL CHARACTERISATION

The measurement system employed here was based on the MEDAV RUSK BRI hardware [8] using a periodic

multitone signal centred at 1920MHz and a measurement bandwidth of 20 MHz. The multi-element dual polarised receiver employed an 8-bit ADC in the receiver, with a sampling rate of 320 MHz. The samples are processed in the DSP and the channel transfer function  $H(f,t)$  is obtained in the frequency domain. The complex Channel Impulse Response (CIR) is then computed via an IFFT in a post-processing stage and over a 5MHz bandwidth representing a TDD channel. A Bubic Temes window function provided an optimum main-lobe and side-lobe width trade-off when computing the IFFT. The channel sounding equipment was also used at Bristol to measure indoor and outdoor UMTS channel characteristics that are reported in [9,10,11].

This paper reports on the results of data collected in two measurement campaigns. The first trial (Section 4.1) enabled a comparison of the fundamental correlation and diversity signal strength characteristics of both Vertical/Horizontal (VH) and  $\pm 45^\circ$  dual polar indoor radio channel to be undertaken. The second trial (Section 4.2) collected data on  $\pm 45^\circ$  and was used in the chip level detector simulations because signals received on  $\pm 45^\circ$  generally offer closer average signal strength levels (See Sect. 4.1).

#### 4.1 Comparison of VH and $\pm 45^\circ$ channels

In this analysis, the receiving array was placed at a height of 2.6m in a typical open-plan office in a modern building with mixed line of sight (LOS) and non-LOS with people freely moving about. The receiving antenna consisted of four micro-strip patch antennas with near identical radiation patterns, each polarised at  $90^\circ$  and  $0^\circ$  (VH), and the trolley mounted transmitter array consisted of four patch antennas polarised at either  $0^\circ$  and  $90^\circ$  or  $\pm 45^\circ$  mounted at a height of 1.5m. Four hundred blocks of Channel Impulse Responses (CIR's) were recorded at 10.24ms intervals (Fig. Appendix A) (well within the typical indoor channel coherence time of 50-100ms) over a four second period. Each block comprised of two  $8 \times 8$  CIR measurement matrix.

The correlation coefficient,  $\rho$ , between the signals from each antenna polarisation [12] determines the gain that can be achieved from PD. If the signals are completely decorrelated then a large performance improvement can be obtained and a 8-10 dB diversity gain has been reported in applying polarisation receive diversity at the receive site in GSM systems [13] and 6dB performance improvement for a CDMA receiver in a typical urban channel [14]. Typically, marked improvements in performance can be obtained if the cross correlation is less than about 0.7 [15]. The distribution in envelope cross correlation coefficient is shown in Fig. 3. It is observed that 90% of all measurements had cross correlations less than 0.5. The coefficient was calculated for

a stationary V/H polarised transmitter to both VH and +/-45 receivers ('VH-HV' and 'VH-45' respectively). The VH-HV provided slightly lower values of  $\rho$  in the static locations. These observations are consistent with those observed in other UMTS channel measurements [16].

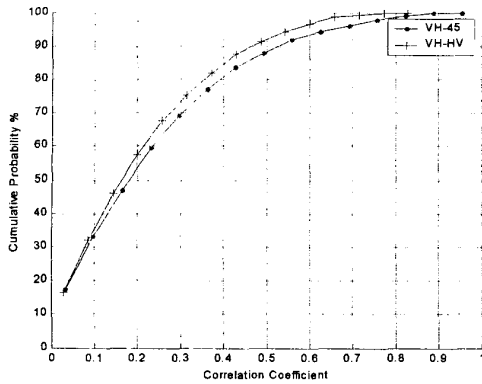

Fig. 3 – Polarisation feed cross correlation CDF

Diversity gain is reduced if there is a large difference in the mean powers [4] as the weaker branch can only contribute a stronger diversity signal for a small fraction of the time. The Cross Polar Discriminant (XPD) is the ratio of received copolar power to cross-polar power. Fig. 4 shows the cumulative XPD distributions. The non LOS channels provide lower average XPD due to more depolarisation of the electromagnetic wave. Further, VH-45 channels generally provide slightly lower average XPDs as it is more probable a vertically polarised wave will be rotated by  $\pm 45^\circ$  than  $90^\circ$ .

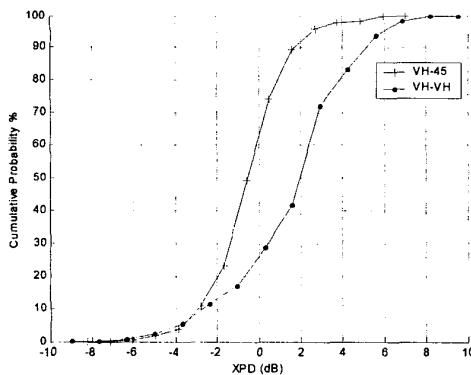

Fig. 4 – XPD CDF

#### 4.2 The $\pm 45^\circ$ Measurement Campaign

In the data presented in this section and onwards the receiving array consisted of eight dual polarised elements allowing spatial, temporal and polarisation data to be

logged. Each element provided  $120^\circ$  beamwidth and had two polarised feeds at  $-45^\circ$  and  $+45^\circ$  and an element gain of 17dBi. One hundred blocks of 256 dual polarised CIR's were taken at 100ms intervals over a 10s period and an interpolation was performed to estimate the CIR at 260ns time bins (3.84Mcps) from the 200ns sampled data. A further linear interpolation provided CIR snapshots for every TDD time slot of  $667 \mu\text{s}$ , as specified in the UTRA TDD specification [6], which have been used in this investigation.

The receiving array was deployed in two different environments: indoor and outdoor to indoor channels. The indoor antenna was placed at a height of 2.2m in the same indoor building as section 4.1. The trolley mounted omni directional dipole transmitter was inclined at  $45^\circ$ , and measurements taken at 15 locations, TX 1 to TX 15. In the Outdoor-Indoor campaign the transmit antenna (17dBi gain and  $65^\circ$  horizontal beamwidth) was located at a height of about 40m on a roof-top building about 180m from the indoor receiver. The 10 seconds of CIR data from each TX location are used to represent the channel of each user communicating from the mobile station (MS) to the Base Station (BS).

Fig. 5 shows that the measured diversity gain provided by Maximum Ratio Combining (MRC) averaged over all the indoor  $\pm 45^\circ$  receiver locations at the 1% cumulative probability level is 2.5dB for channel one and 3.2dB for channel two.

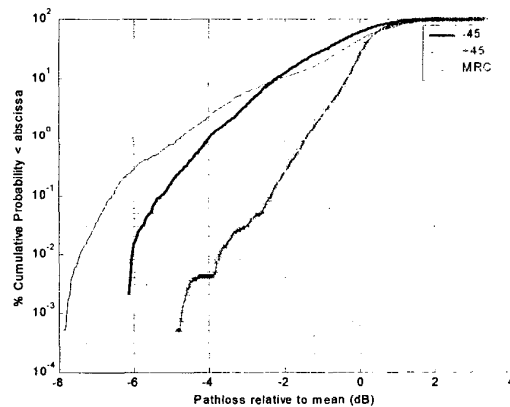

Fig. 5 – Indoor signal strength combining performance

#### 5. DETECTOR ARCHITECTURES

Three different single and dual polar detectors were simulated as the basic detector in each stage of the multi-stage canceller: (i) conventional rake, (ii) standard post combining LMMSE and (iii) adaptive rake.

### 5.1 Dual Polar detector architectures

The filter coefficients in the standard Linear Minimum Mean Square Error (LMMSE) adaptive filter, where interference is suppressed after multipath combining, are obtained by minimising the Mean-Square Error (MSE) between the desired bit and the estimated bit. The desired bit is obtained from either a training sequence or “bit estimate feedback” in decision directed mode. The cost function,  $J$ , is:

$$J = E \left[ \left| \mathbf{b} - \hat{\mathbf{b}} \right|^2 \right] \quad (1)$$

where,  $\mathbf{b}$  = user symbol matrix.

Each finger of the adaptive rake is composed of an independent LMMSE adaptive filter and the interference is suppressed before the multipath is combined [17]. The update algorithm is based on minimising the error between the channel bit product,  $\mathbf{h}$ , and the filtered received signal product,  $\hat{\mathbf{h}}$ . The LMS tap update algorithm is a recursive method for iteratively solving equation (2) and is given by:

$$\mathbf{w}_k^{(n)} = \mathbf{w}_k^{(n-1)} + \mu_k^{(n)} e_k^{(n)} \bar{\mathbf{r}}^{*(n)} \quad (2)$$

Where,  $\mathbf{w}^{(n)}$  is the new tap weights,  $\bar{\mathbf{r}}^{*(n)}$  the filter input vector, and  $e_k^{(n)}$  is the error at bit  $n$  of user  $k$ .

The dual polar detectors consist of two single detectors applied to each cross element polarisation feed and determine the bit from the combined correlator outputs. Equal Gain Combining (EGC) can be applied if the average SNR on each branch is similar and requires less processing than MRC which applies a weight proportional to the correlator output.

### 5.2 Multistage Interference Canceller

Multistage detectors are non-linear in that estimated MAI is subtracted from the composite signal for all or a subset of interferers before estimation of the desired user. The user received with the highest power is detected first and the proportion of interference cancelled is usually increased at each stage (Fig. 6) as the reliability of the estimates increase [19]. The level of interference subtracted at stage 1 of the canceller was set to 20%, rising to 40% in stage 2 and 60% in stage 3.

For each symbol the three basic detectors are executed in parallel: the conventional rake, the pre-combining LMMSE and the post-combining LMMSE. In high noise, the adaptive detectors with decision feedback can perform

worse than the conventional rake [19] and the conventional rake can therefore be used to regenerate the interference.

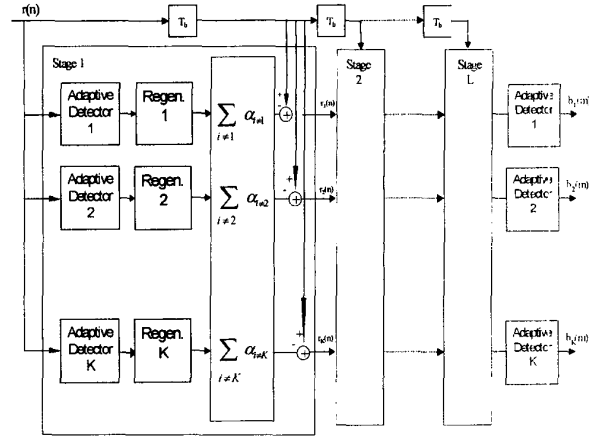

Fig. 6 – Multistage interference canceller

## 6. DETECTOR PERFORMANCES

A software-based analysis was performed for a TD-CDMA system. QPSK modulated spread spectrum signals were created for five in-cell SF16 users, consisting of 3 indoor Tx locations and two outdoor to indoor channels, using 8 samples per chip. Spreading was achieved by Orthogonal Variable Spreading Factor (OVSF) codes multiplied by a cell specific scrambling code. Each time slot consisted of two 976-chip data sections separated by a 512-chip training sequence, and a guard period is inserted at the end. Channel coding was not employed. The sequence was then Nyquist root raised cosine transmit filtered with  $\alpha=0.22$ , convolved with a user independent wideband channel (obtained from the wideband field trials) that was assumed known at the receiver, and similarly receive root raised cosine filtered. Independent AWGN was then added to the composite signal on each branch. A dynamic path search procedure was employed to assign correlators to the bins where the highest multipath energy was received, and MRC was employed both for combining these multipaths and the two polarisation branches.

At 8dB Eb/No a 4.5dB BER performance improvement was observed for the LMMSE Rake-DP and a 3.8dB gain for the DP rake detector (Fig. 7). The conventional rake detectors show an interference floor where cross correlation products dominate and increases in SNR do not improve the BER.

8. CONCLUSION

Channel impulse responses obtained from a spatio-temporal field trials campaign considered representative of a UTRA TDD indoor and outdoor deployment were used in demonstrating the potential of interference cancellers employing a dual polarised antenna. At 8dB Eb/No a 4.5dB BER performance improvement was observed for the dual polar adaptive rake and a 3.8dB gain for the dual polar rake detector. A major advantage of polarisation diversity is that the co-location of orthogonal antenna elements makes them very compact.

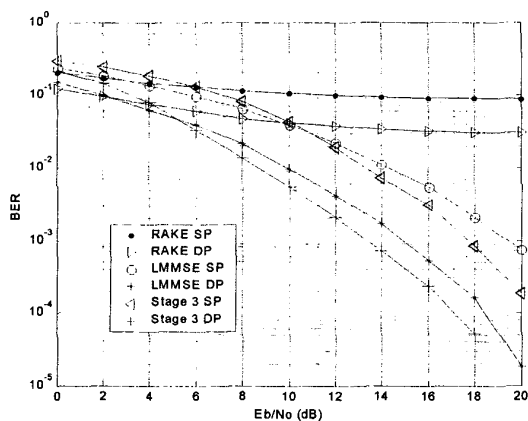

Fig. 7 – SF16 BER performance

ACKNOWLEDGEMENTS

Julian Webber wishes to thank Toshiba TREL, Bristol for their student sponsorship. The authors wish to thank the HEFCE for their support in the procurement of the Medav system and Allgon, Sweden for the loan of the antenna array.

REFERENCES

[1] K. Richardson, "UMTS overview", pp.93-100, Electronic Comm. & Engineering Journal, IEE, June 2000.  
 [2] M. Beach & S. Allpress, "Propagation aspects of mobile spread spectrum networks", Chapter 12 in 'IEE Radiowave Propagation', IEE, 1994.

[3] R. Vargas, E. Baker & K. Baker, "Polarisation diversity for indoor cellular and PCS CDMA reception", pp. 1014-1018, VTC proceedings, 1997.  
 [4] N. Correal & B. Woerner, "Enhanced DS-CDMA uplink performance through base station polarisation diversity and multistage interference cancellation", Globecom 1998.  
 [5] ETSI, "Physical channels and mapping of transport channels onto physical channels (TDD)", (3G TS 25.221 10/1999).  
 [6] T. Ojanpera and R. Prasad, "An overview of Air Interface Multiple Access for IMT-2000/UMTS", IEEE Communications Magazine, pp. 82-95, Sep. 1998.  
 [7] W. Stutzman, "Polarisation in electromagnetic systems", Artech House, Boston, USA, 1993.  
 [8] www.medav.de  
 [9] M. Beach, B. Allen & P. Karlsson, "Spatial decorrelation of frequency division duplex links", Electronic Letters, vol. 36, No. 22, pp. 1854-1855, 26<sup>th</sup> Oct. 2000.  
 [10] B. Allen, J. Webber, M. Beach & P. Karlsson "UMTS spatio-temporal trials results", IEE International Conference Antennas and Propagation, 2001.  
 [11] J. Webber, B. Allen, M. Beach, P. Karlsson & N. Canagarajah, "Performance investigation of multiuser detectors employing a dual polarised antenna", EPMCC 2001 Proceedings.  
 [12] S. Kozono, T. Tsuchida & M. Sakamoto, "Base station polarization diversity reception for mobile radio", pp. 301-306, IEEE Trans. On Vehic. Tech., Vol. VT-33, No. 4, Nov. 1984.  
 [13] M. Smith & L. Neal, "A comparison of polarisation and space diversity for indoor propagation at 900 MHz", pp. 74-78, IEEE ICUPC proceedings 1993.  
 [14] P. Jung, J. Blanz, "Joint detection with coherent Receiver antenna diversity in CDMA mobile radio systems". IEEE Trans. on Vehic. Tech. Vol. 44, No. 1, pp. 76-88, Feb. 1995.  
 [15] A. Turkmani, A. Arowojolu, P. Jefford & C. Kellert, "An experimental evaluation of the performance of two-branch space and polarisation diversity schemes at 1800 MHz", pp. 318-326, IEEE Trans. on Vehicular Technology, Vol. 44, No. 2, May 1995.  
 [16] L. Lukama, K. Konstantinou & D.J Edwards, "Polarization diversity performance for UMTS", 11<sup>th</sup> Int. Conf. On Antennas and Propagation, ICAP 2001, IEE, April 2001.  
 [17] M. Latva-Aho, "Reconfigurable adaptive RAKE receiver for wideband CDMA Systems", VTC 98, IEEE 1998.  
 [18] D. Divsalar, M. Simon & D. Raphaeli, "Improved parallel interference cancellation for CDMA", IEEE Trans. on Commun., pp. 258-268, Vol. 46, No. 2, IEEE Feb. 1998.  
 [19] Y. Bian, A. Nix & J.P. McGeehan, "Performance analysis of a blind adaptive linear minimum squared error receiver for use in UMTS TDD-CDMA Basestations", VTC 2001.

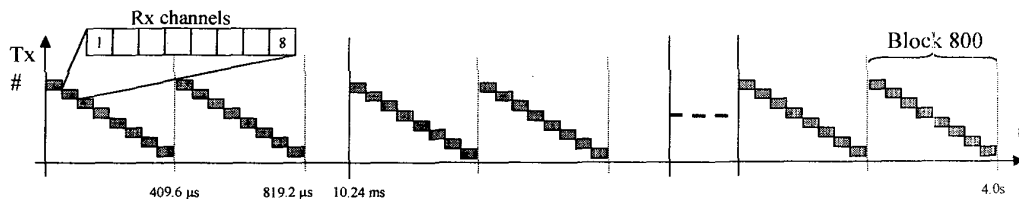

Fig A – Channel Measurement Timing Diagram