



Bian, YQ., & Nix, AR. (2006). Throughput and coverage analysis of a multi-element broadband fixed wireless access (BFWA) system in the presence of co-channel interference. In *IEEE 64th Vehicular Technology Conference, 2006 (VTC-2006 Fall), Montreal* (pp. 1 - 5). Institute of Electrical and Electronics Engineers (IEEE).
<https://doi.org/10.1109/VTCF.2006.30>

Peer reviewed version

Link to published version (if available):
[10.1109/VTCF.2006.30](https://doi.org/10.1109/VTCF.2006.30)

[Link to publication record in Explore Bristol Research](#)
PDF-document

University of Bristol - Explore Bristol Research

General rights

This document is made available in accordance with publisher policies. Please cite only the published version using the reference above. Full terms of use are available:
<http://www.bristol.ac.uk/red/research-policy/pure/user-guides/ebr-terms/>

Throughput and Coverage Analysis of a Multi-Element Broadband Fixed Wireless Access (BFWA) System in the Presence of Co-Channel Interference

Y.Q. Bian and A.R. Nix

{y.q.bian; andy.nix}@bristol.ac.uk



University of
BRISTOL

Ofcom
OFFICE OF COMMUNICATIONS

TOSHIBA

CCR
centre for
communications
research

Introduction

- Study builds on IEEE 802.16-2004 (16d) fixed broadband wireless access standard (fixed WiMAX)
- Channel model for fixed WiMAX in urban environments
 - SUI (Stanford University Interim)
 - Site specific model (urban ray tracing)
- Analyse channel and interference behaviour within a WiMAX network
- Work towards achieving high system throughput using the OFDM-wirelessMAN air interface by exploiting sectorised MIMO arrays
- Conclusions

Background (IEEE 802.16-2004)

- Fixed WiMAX provides a cost-effective wireless network over extensive areas to large number of users; it provides differentiated broadband service
- The IEEE 802.16-2004 standard defines three PHY layer air-interface techniques
- The 256-FFT OFDM solution is favoured by the vendor community, since OFDM improves system performance in non-line-of-sight urban environments
- UK has 3.5GHz licensed band
- WiMAX supports:
 - Adaptive modulation and coding (AMC)
 - Smart antennal techniques

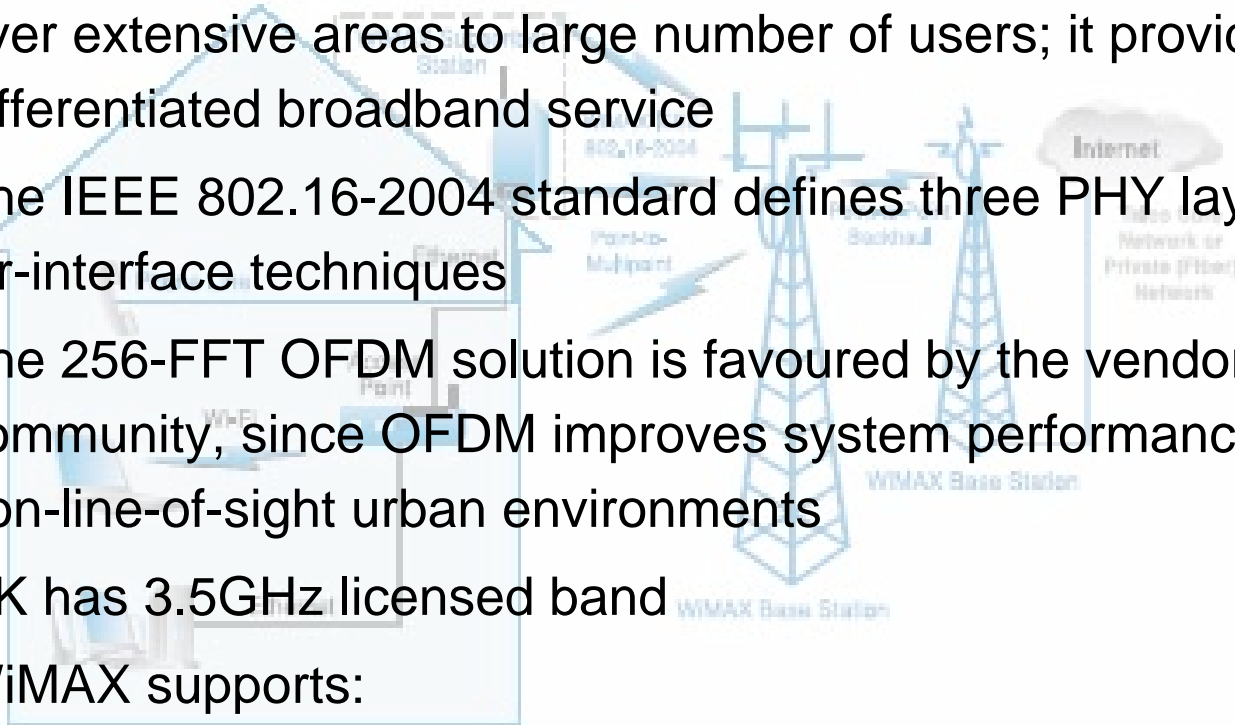

SUI Channel Models (1)

- SUI models are widely used for fixed WiMAX deployment. A total of six models are defined for three typical terrain types

	K factor	$\tau_{rms}(\mu s)$	Ant. Corre.	Terrain type
SUI-1	Omni: 3.3(90%), 10.4(75%)	0.111	0.7	C
	30° ant.: 14(90%), 44.2(75%)	0.042		
SUI-2	Omni: 1.6(90%), 5.1(75%)	0.202	0.5	C
	30° ant.: 6.9(90%), 21.8(75%)	0.069		
SUI-3	Omni: 0.5(90%), 1.6(75%)	0.264	0.4	B
	30° ant.:2.2(90%), 7.0(75%)	0.123		
SUI-4	Omni: 0.2(90%), 0.6(75%)	1.257	0.3	B
	30° ant.:1.0(90%), 3.2(75%)	0.563		
SUI-5	Omni: 0.1(90%), 0.3(75%), 1.0(50%)	2.842	0.3	A
	30° ant.:0.4(90%), 1.3(75%), 4.2(50%)	1.276		
SUI-6	Omni: 0.1(90%), 0.3(75%), 1.0(50%)	5.240	0.3	A
	30° ant.:0.4(90%), 1.3(75%), 4.2(50%)	2.370		

Type A: hilly terrain with moderate-to-heavy tree densities;
 Type C: mostly flat terrain with light tree densities.

SUI Channel Models (2)

Scenario for SUI channel:

1. Cell size:	7 km
2. BS ant. high:	30m
3. CPE ant. High:	6m
4. BS ant. beamwidth:	120°
5. CPE ant. Beamwidth:	omni & 30°
6. Polarization	Vertical
7. Cell coverage	90% with 99.9% reliability

- The SUI approach struggles to support link adaptation studies and is not ideal for calculating the coverage outage probability, since it makes a number of general assumptions (see above)
- To overcome these limitations and assumptions, we use a site specific Ray Tracing (RT) model to analyse the radio channels between each BS and their associated CPEs

Simulation Scenarios

- 3km by 1.8km area covering central Bristol (UK)
- 5 BS placed on tall local buildings (~30m height); each BS uses three 120° sectorised antennas
- 100 CPEs are located at rooftop height (around 6m), and use omni or 30° directional elements
- Consider two MIMO array configurations: 1) Uniform Circular Array (UCA), and 2) Uniform Linear Array (ULA)
- 5MHz channel bandwidth assumed in the 3.5GHz band

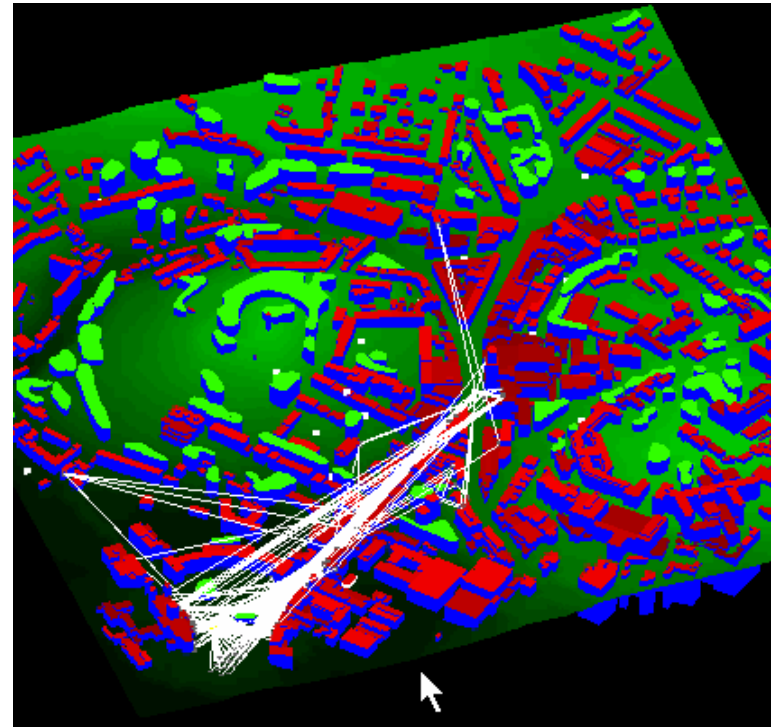

MIMO Channel for Sectorised Multi-BS Network

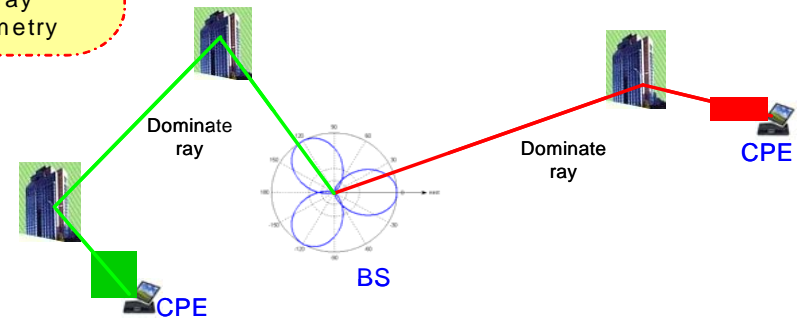
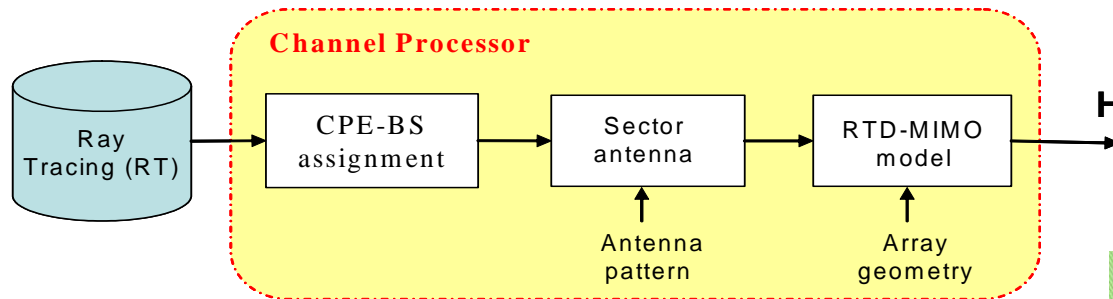

- Utilises urban geographic data to produce spatial/temporal channel using isotropic element patterns.
- ETSI specified beam patterns are then spatially convolved to model the impact of directional elements
- CPE to BS-Sector assignment and orientation based on strongest path

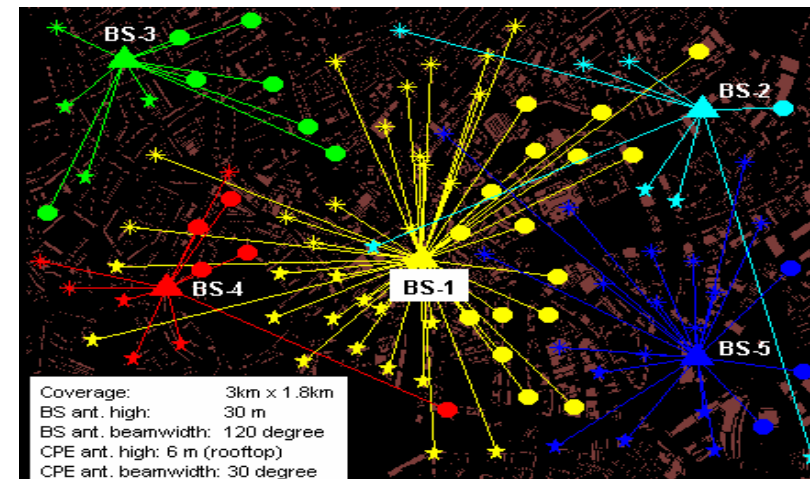

Ray Tracing Deterministic (RTD) - MIMO Channel (1)

- Spatial correlations are determined by the spatial directions of the multipaths (AoD/AoA) and the array geometry
- Frequency correlations are controlled by channel time delay spread.

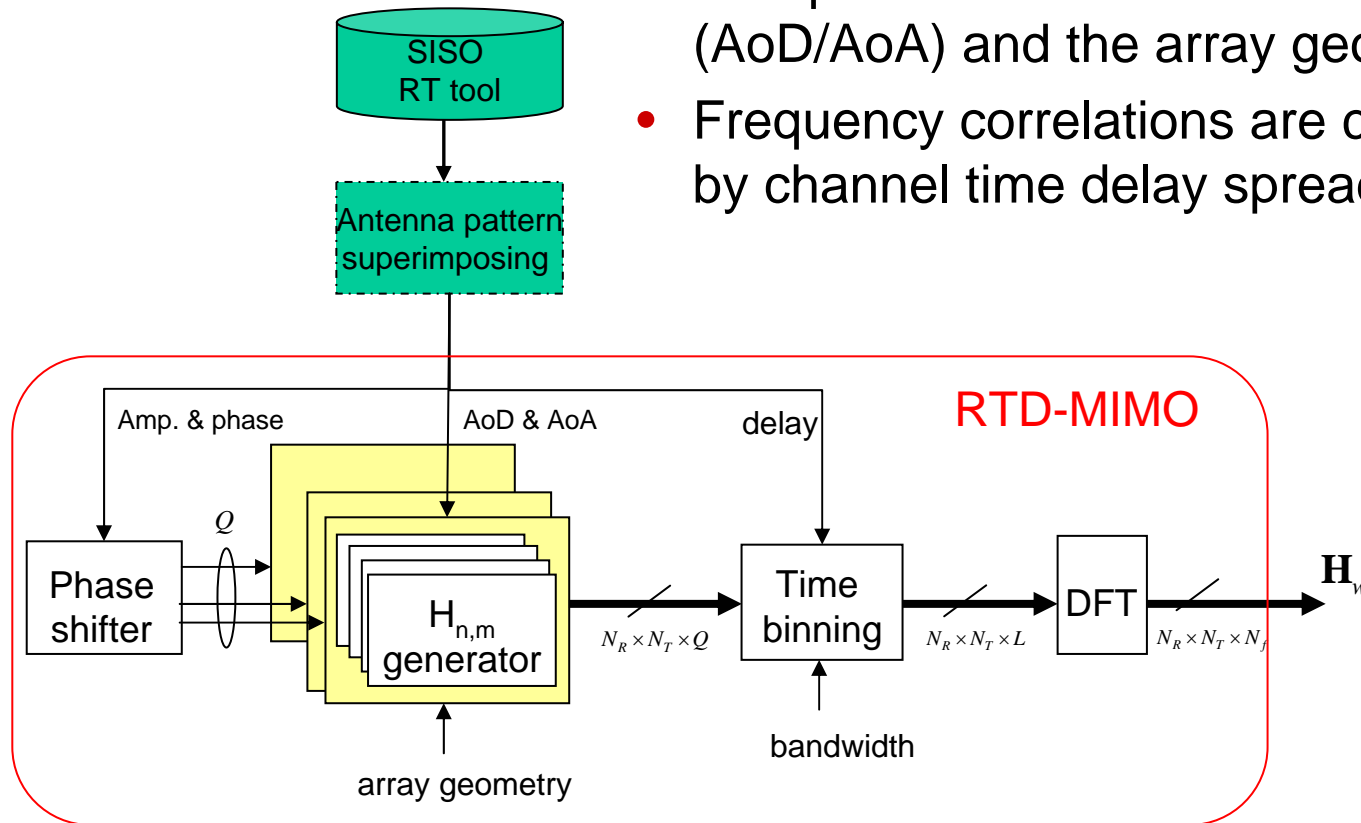

RTD - MIMO Channel (2)

- The plot below shows the time varying Tapped Delay Line weights, and the resulting frequency selective channel responses for the MIMO links
- Each MIMO link suffers individual frequency selective fading

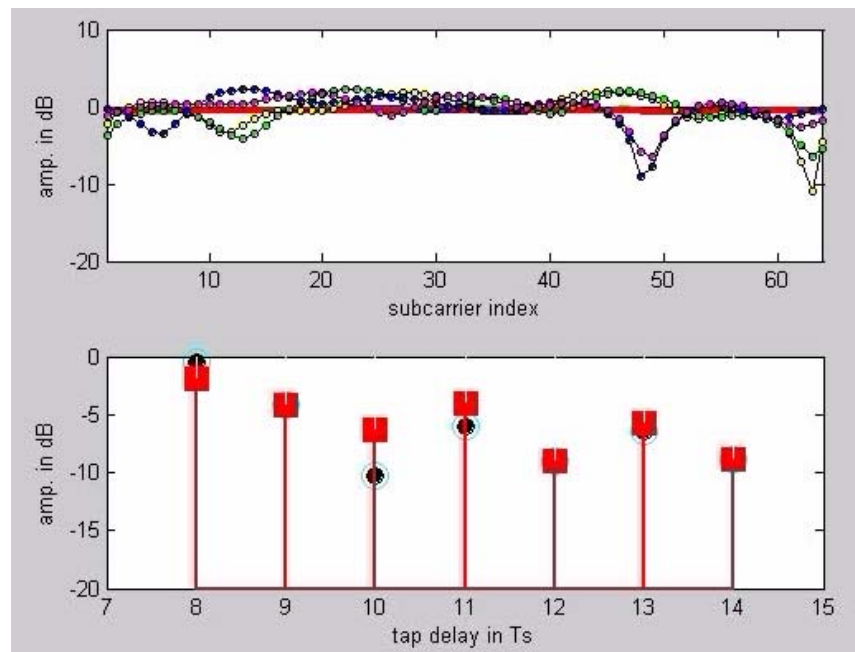

Comparison between RT and SUI model

- The RT results demonstrate that:
 - 73% of users have a very strong dominant ray (a K-factor above 15dB). Simulated area fits the *SUI-3 assumptions* (terrain type B)
 - 30° directional antenna increases the K-factor
 - RMS Angle Spread is much lower in Elevation (compared to Azimuth)

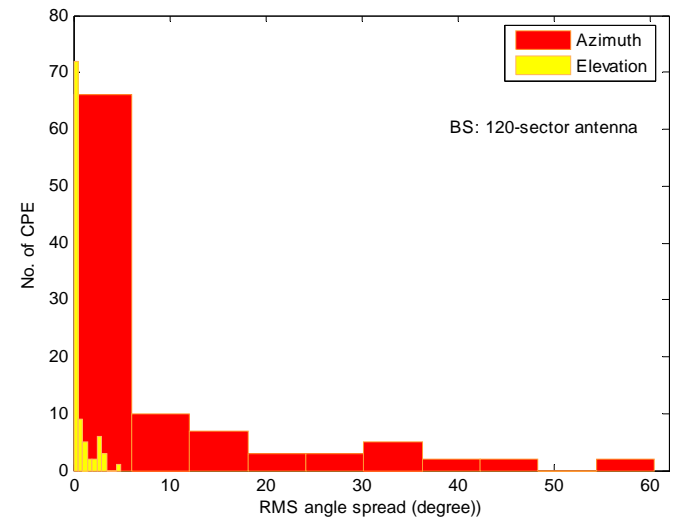
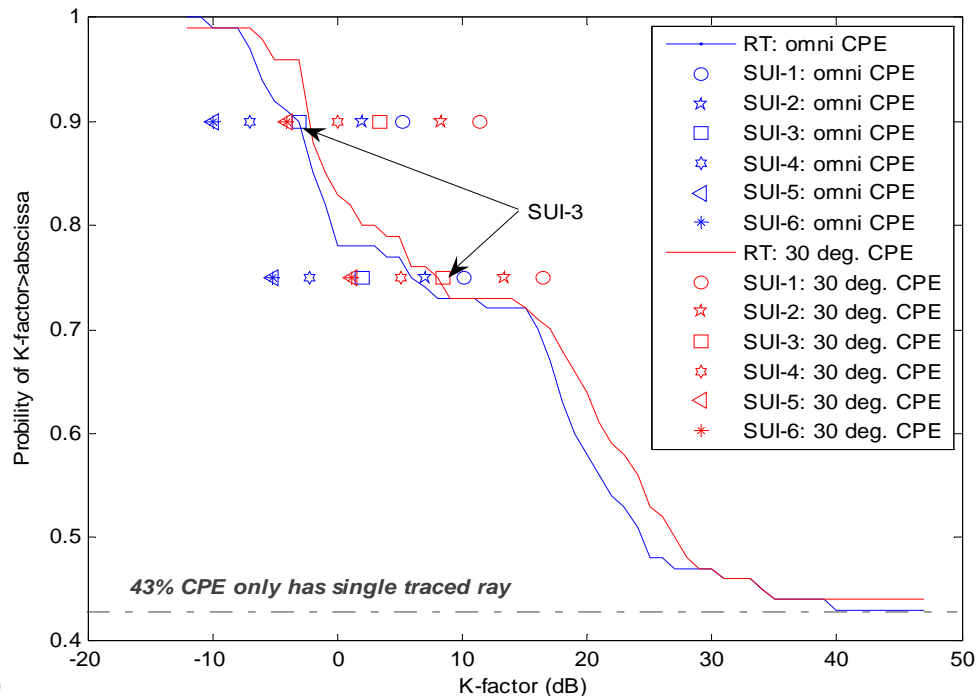

Array Element Geometry

- Higher spatial correlation seen between vertically displaced array elements. Consequently, it is more effective to space MIMO elements in the horizontal plane
- The figure below shows the structure of the MIMO sectorised array

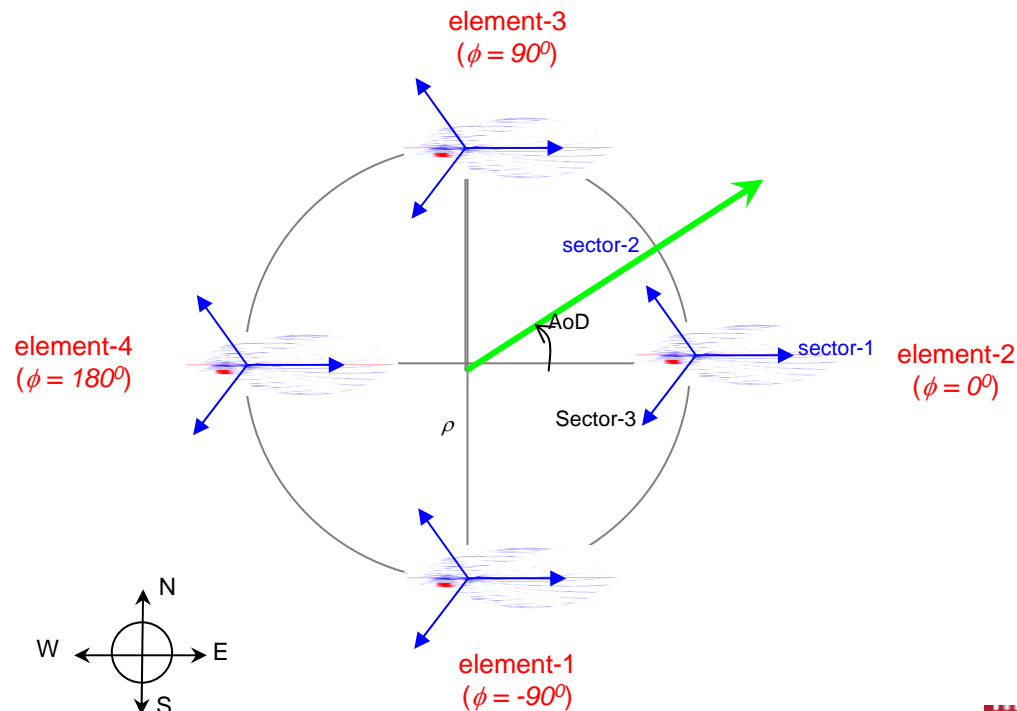

Interference in multi BS environment (1)

$$C = \log_2 \det \left(I_{N_R} + \frac{SINR}{N_T} \mathbf{H}\mathbf{H}^H \right)$$

- Co-Channel Interference (CCI) has a harmful effect on capacity (depending on the frequency reuse plan)
- Key challenges include improving throughput, spectrum efficiency and coverage

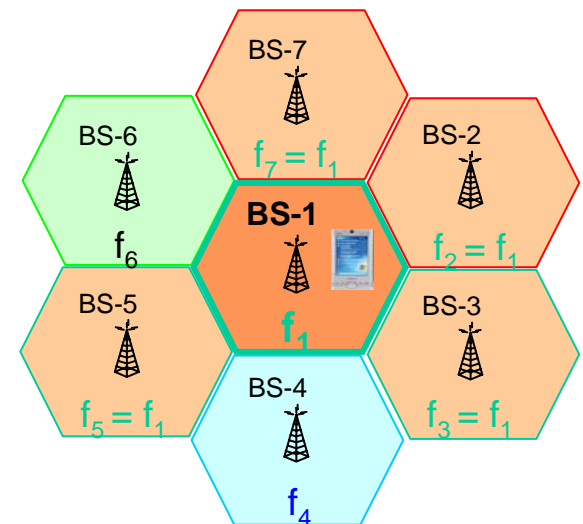

C/I Distributions

- Systems with directional antenna are likely to 'see' high coverage through the use of higher link-speeds
- Performance of Interference Cancellation (IC) depends on the specific channel characteristics

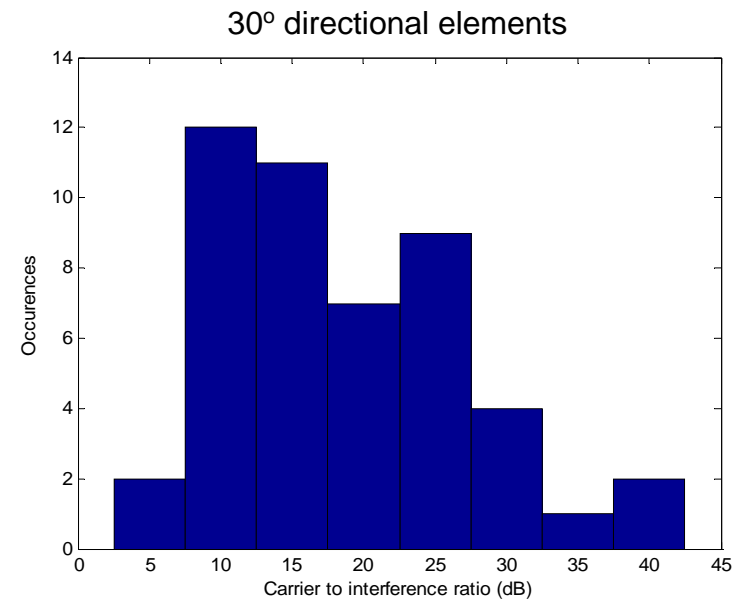
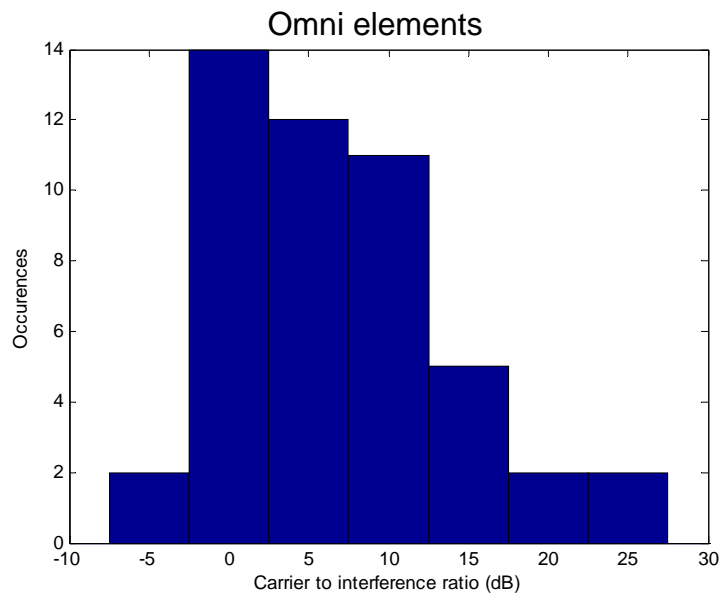

Interference in multi BS environment (2)

- MIMO spatial correlation further reduces capacity

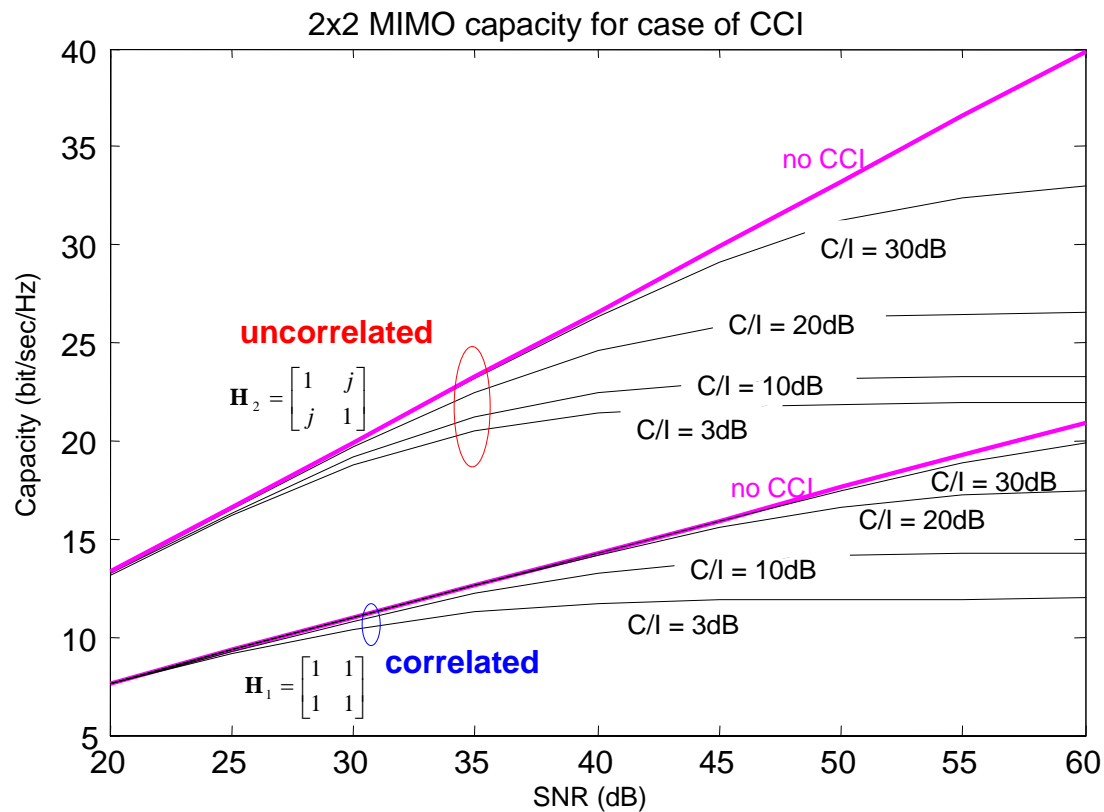

Array Geometry Impact on MIMO Performance

- RCN values quantify MIMO spatial correlation and reflect channel capacity
- ULA geometry works well when the channel is characterized by low correlation
- When MIMO channels are highly correlated, UCA structures outperform their ULA counterparts

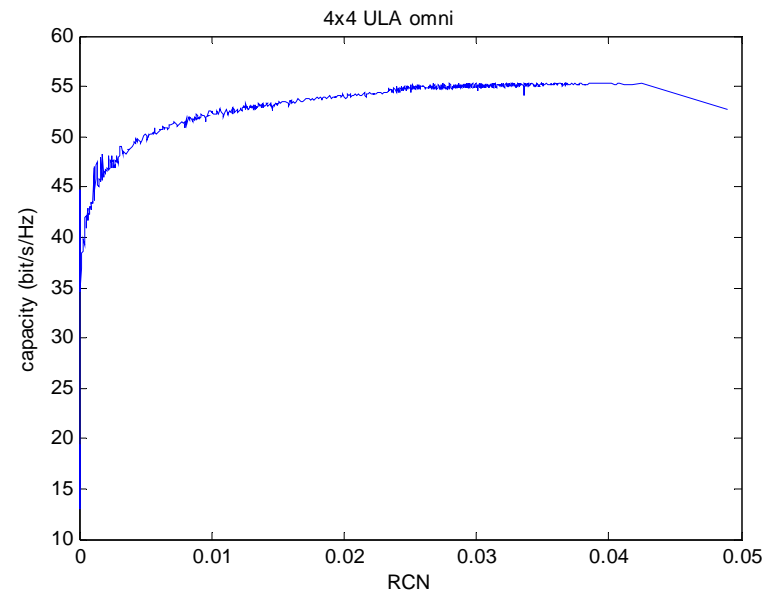

4x4 MIMO channel RCN for ULA omni antennas



4x4 MIMO channel RCN for UCA omni antennas

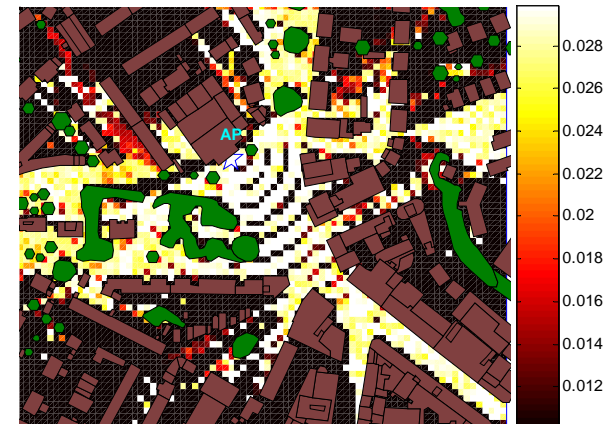

RCN: Reciprocal Condition Number
ULA: Uniform Linear Array
UCA: Uniform Circular Array

Results Analysis

- In the presence of CCI, there is a trade-off between interference suppression (using narrow beamwidths) and diversity gain (using wider beamwidths).
- We recommend:
 - Wide MIMO element spacings (e.g. 5λ for the BS and 0.5λ for the CPE);
 - Deploying MIMO arrays in the horizontal plane. UCA (4x4 MIMO) works well for open areas.
- Compared to SISO, the sectorised 2x2 MIMO system improved coverage of the highest link speed by 12%. Hence system throughputs are improved by 1.5Mbps.

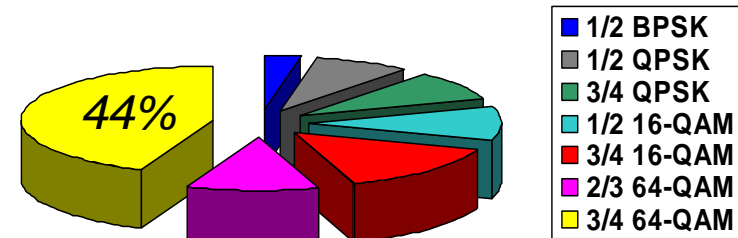

SISO system throughputs: 11.4Mbps

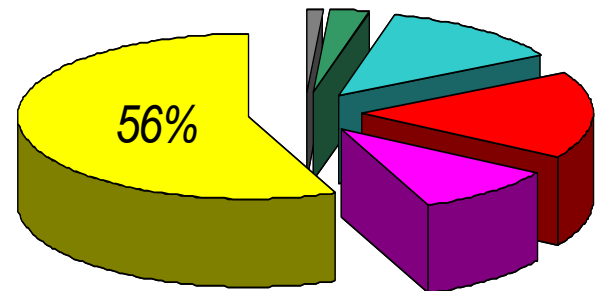

2x2 MIMO system throughputs: 12.9Mbps

Conclusions

- Radio channel plays an important role in system evaluation. Our RTD-MIMO can simulate propagation across transition regions, and thus presents a unique insight into system coverage and throughput.
- We have demonstrated WiMAX performance in a practical urban environment, and shown degradation due to path loss, spatial correlation and inference.
- Our results show that:
 - Sectorised antenna system consistently offers higher C/I than omni antenna equivalents. However, they still cannot achieve full coverage and high throughputs on their own
 - Sectorised MIMO arrays offer significant benefits (i.e. the 1.5Mbps improvement seen in this study), even with many LoS channels