



Walsh, J. A., & Berthoud, L. (2016). *Is it possible to integrate Electric Propulsion thrusters on Very-Low Earth Orbit Microsatellites?*. Paper presented at Space Propulsion 2016, Rome, Italy.

Peer reviewed version

License (if available):
Unspecified

[Link to publication record on the Bristol Research Portal](#)
PDF-document

University of Bristol – Bristol Research Portal

General rights

This document is made available in accordance with publisher policies. Please cite only the published version using the reference above. Full terms of use are available:
<http://www.bristol.ac.uk/red/research-policy/pure/user-guides/brp-terms/>

Is it possible to integrate Electric Propulsion thrusters on Very-Low Earth Orbit Microsatellites?

MARRIOTT PARK HOTEL, ROME, ITALY / 2–6 MAY 2016

Jonathan A. Walsh ⁽¹⁾, Lucy Berthoud ⁽¹⁾

⁽¹⁾ University of Bristol, Queen's Building, University Walk, Bristol, UK BS8 1TR,
Email: jonathan.walsh@bristol.ac.uk

Keywords: Direct Simulation Monte Carlo, Very-Low Earth Orbit, Drag Modelling, Microsatellites

Abstract:

This study explores the effects of drag on satellites operating in a Very-Low Earth Orbit and the feasibility of using Electric Propulsion to provide drag compensation to extend their operational life. Very-Low Earth Orbit (VLEO) describes the orbital altitudes below 250km and operating a remote sensing satellite in this region has several benefits. Due to increased air density at these low altitudes, a satellite would experience comparatively larger drag forces which would normally cause it to de-orbit within a few days. Drag calculations were performed on a satellite's body for altitudes of 160km to 250km using the Direct Simulation Monte Carlo technique via the DS2V code. The orbit of the Satellite was simulated using NASA's General Mission Analysis Tool (GMAT) to calculate the required thrust levels for a Noon and Dawn-Dusk Sun-Synchronous orbit under both a continuous thrusting Regime and a daytime only thrusting regime.

1. Introduction

Very-Low Earth Orbit (VLEO) describes orbital altitudes below 250km and operating a remote sensing satellite in this region has many benefits. The closer an imager is to the target, the smaller in size and mass this imager can be. This could lead to a reduction in the power requirements and an

improvement in the downlink data rate [1] [2]. The reduced mass of the payload also opens up the potential to embark the payload on microsatellites (mass 10-100kg).

A defining characteristic of VLEO is the significant levels of drag on the satellite from the residual atmosphere. This would normally cause it to de-orbit within a few weeks, however, if propulsion subsystems can be embarked to compensate the drag then operational life can be improved. This was demonstrated by the European Space Agency's (ESA) Gravity Field and Steady-State Ocean Circulation Explorer (GOCE) which sustained an orbital altitude of 260km using electric propulsion for 55 months before running out of fuel [3]. The Japanese Aerospace Exploration Agency (JAXA), have also been working on their own Super Low Altitude Test Satellite (SLATS) which they hope to launch late 2016 [4]. After descending from its insertion altitude of 630km, SLATS is only expected to operate in VLEO for 90 days. During this time it will perform measurements of atmospheric density in order to improve the atmospheric models in this region.

This study explores the effects of drag on satellites operating in a VLEO and the feasibility of using Electric Propulsion to provide drag compensation to extend operational life.

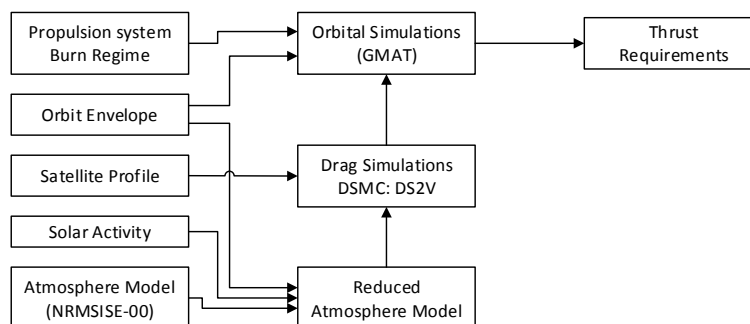

Figure 1: Method of working

2. Method

2.1. Method of working

The required thrust was determined by performing orbital simulation in NASA's General Mission Analysis Tool (GMAT). This required the definition of an orbit envelope, in this case sun-synchronous orbits of 160-250km in altitude, and of possible thrust regimes which could be used by the propulsion system (see Section 2.2 for further details).

To model the drag on the spacecraft, GMAT required the coefficients of drag for the spacecraft. These were calculated using the Direct Simulation Monte Carlo software DS2V (Section 2.5) and required the profile of the satellite (Section 2.3) as well as the densities and molecular composition of the atmosphere at each altitude. A reduced atmosphere model was created by calculating an average value for the densities and composition across the VLEO altitudes using the atmosphere model NRLMSISE-00 for high solar activity (Section 2.4).

2.2. Orbit Selection and Presumed Mission

The VLEOs examined for this study were from an altitude of 250km down to 160km. The main mission application considered is for Earth Observation using a Sun Synchronous Orbits (SSO). A Dawn-Dusk SSO (Local Time at Ascending Node (LTAN) = 0600) was considered as this typically receives the most sunlight over the course of an orbit, making it ideal for payloads with high power demands. A noon SSO was also considered, as it experiences the longest eclipse period, in addition to a large variation in atmospheric density, and thus provides a suitable worst case for analysis.

Table 1: Mission Envelope Summary

Orbital Altitudes	160 – 250 km
Orbit Type	Sun-Synchronous Orbit
LTAN	6:00 (Dawn-Dusk) & 12:00 (Noon)
Epoch	01 Jan 2002

2.3. Satellite Configuration

In order to model a microsatellite, an upper mass limit of 100kg was assumed, with exterior dimensions of 0.5m x 0.5 m x 1.0 m (see Figure 2 for the satellite profile), The frontal area for the profile was taken to be 0.25 m² with a width of 0.5 m and a prismatic section. This configuration should provide sufficient internal volume while also presenting a small area to the flow.

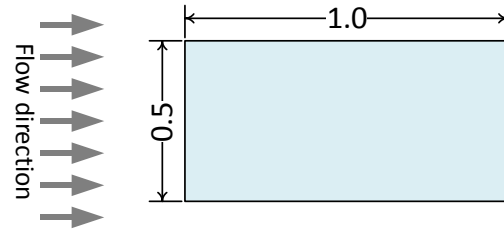

Figure 2: Assumed satellite Profile (metres)

For simplicity, solar arrays are assumed to be body-mounted for this study. It is anticipated that deployable solar arrays will be needed to provide the power for the propulsion system. Deployable arrays would affect the drag and were not considered in this first iteration.

Table 2: Summary of VLEO Satellite Configuration

External Dimensions	0.5m x 0.5 m x 1.0 m
Frontal Area	0.25 m ²
Mass	100 kg

2.4. Atmospheric Model

The orbital altitudes under discussion fall within the lower portion of the Earth's Thermosphere and experience significantly higher drag than conventional Low Earth Orbit satellites. To model the neutral atmosphere, the composition, density and temperature of the thermosphere across the range of orbits need to be specified. The NRLMSISE-00 atmospheric model [5] was used (as recommended in the ECSS-E-ST-10-04C [6]). The gas species modelled were: Oxygen (O₂), Nitrogen (N₂), Atomic Oxygen (O), Atomic Nitrogen (N), Argon (N), Helium (He) and Hydrogen (H).

Table 3: Average Thermospheric properties at an altitude of 190 km from NRLMSISE-00 [5]

Solar Activity		High	Low
F10.7		215.5	67.3
Density	[kg/m ³]	5.31E-10	2.63E-10
Temp	[K]	1117	686
O	[%]	45.8677	48.0289
N2	[%]	50.4514	48.291
O2	[%]	2.9547	3.3025
He	[%]	0.0767	0.1993
Ar	[%]	0.0687	0.0445
H	[%]	0.0003	0.0086
N	[%]	0.5802	0.1251

At any given altitude, the properties of the thermosphere are not uniform, varying with the Day/Night cycle as well as the Earth's ground topology. This means over a single orbit, the density

and composition of the atmosphere can vary significantly. To facilitate the calculation of the drag, an average density and composition was computed for each altitude, as summarised in Figure 3 and Table 3.

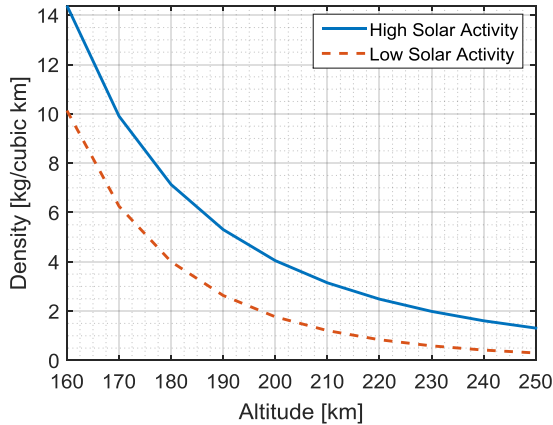

Figure 3: Atmosphere Density from NRLMSISE-00 used during Drag modelling

These properties also vary as a function of solar irradiance, and the eleven year solar cycle. In order to calculate a worst case analysis, the properties of the thermosphere at the last maximum solar flux were used ($F_{10.7}=215.5$). These are summarised in Table 3 for 190km with low solar flux ($F_{10.7}=67.3$) for comparison.

2.5. Drag Simulation

As can be seen from Figure 3, the density of the atmosphere for VLEO orbits is very low (1.17×10^{-7} % of sea level density) and the molecules have a high mean free path. The Knudsen Number (K_n) describes the ratio between the molecular free path and the size of the object (equation 1) [7]. A high Knudsen Number flow ($K_n \gg 1$) is described as a 'free molecular flow'. Using the forward elevation as the reference length (0.5m), initial calculations showed the free flow Knudsen Number varied from 125 at 160km to 3124 at 250km. The flow around the satellite under consideration is therefore a free molecular flow right down to 160 km.

$$K_n = \frac{\text{mean free path}}{\text{Ref.Length}} \quad 1$$

In order to model the free molecular flow around the satellite and calculate drag, the Direct Simulation Monte Carlo software 'DS2V', developed by Bird, was used [8]. It was chosen as it is a proven and well documented code and to allow compatibility with previous work [1] [2]. A 3D version (DS3V) is

also available, however, the size and placement of the solar arrays and other externally mounted equipment was not known at this stage, thus the additional accuracy and computational load was considered unnecessary.

2.6. Orbit Simulation

To simulate the orbit of the Satellite and calculate the thrust level requirements, NASA's General Mission Analysis Tool (GMAT) was used. For each scenario, the satellite dynamics were simulated for 30 orbits after which the change in the eccentricity and semi-major axis were required to be less than 1×10^{-4} and 10m respectively.

Two flight strategies were examined: a Continuous thrusting regime and Daytime thrusting regime. The Continuous thrusting regime assumes the thruster is firing constantly for the entire period of the orbit, while the Daytime thrusting regime assumes that the thruster is only thrusting while the satellite is not in eclipse. In a Noon SSO the eclipse at the altitudes under consideration lasts about 37 minutes. It is interesting to note that below about 290km altitude, a Dawn-Dusk SSO does have an eclipse, see Figure 7. This eclipse varied from 20 minutes at 160km to 10 minutes at 250km.

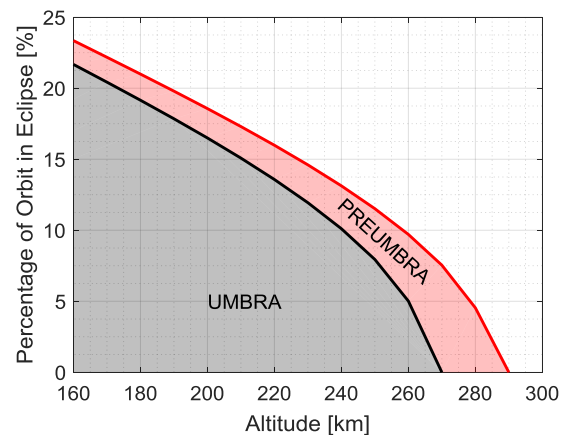

Figure 4: Percentage of orbit a Dawn-Dusk SSO Satellite (LTAN=0600) spent in eclipse according to GMAT model with epoch 01 Jan 2002.

Many payloads simply need to remain in orbit. For this model, it was assumed that the propulsion system provided a constant thrust for the duration of the burn for both regimes.

3. Thruster selection

3.1. Altitude and Drag

Using DS2V, the drag on the Body was calculated for the VLEO of 160km - 250km using 10km steps and Figure 5 shows the decrease in drag with increasing altitude.

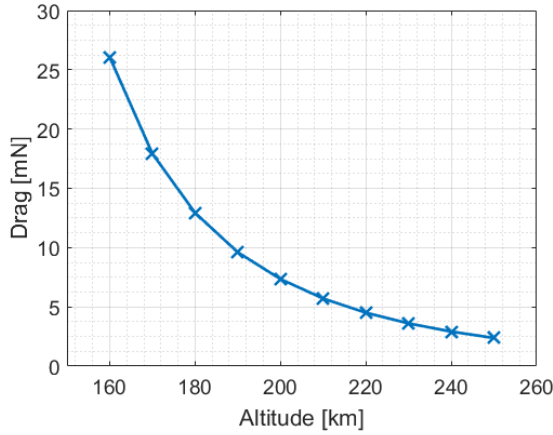

Figure 5: Variation of Drag with Altitude calculated using DS2V

The drag coefficients were calculated using the frontal area of the satellite as the reference area (0.25m²) and the drag equation (equation 2), See Figure 6.

$$F = \frac{1}{2} A_{Ref} V^2 C_D \quad 2$$

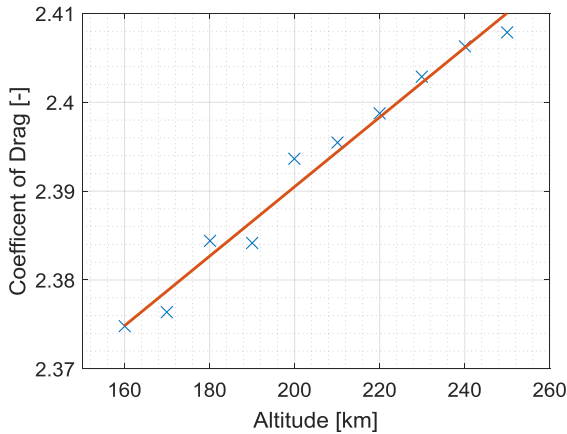

Figure 6: Variation of Drag Coefficient with Altitude (Reference Area = 0.25)

There is a correlation between the coefficient of drag and the satellite's altitude. The dominant parameter changing with altitude is the air density and there is a logarithmic relationship between the two (Figure 7). Therefore by fitting a curve to the

data, equation 3 was generated where ρ is in kg/km³, and is valid for densities of 0.1 kg/km³ -1.5 kg/km³. This was used in the GMAT simulation to model the variation of the Drag Coefficient with atmospheric density.

$$C_D = -0.015 \ln(\rho) + 2.3782 \quad 3$$

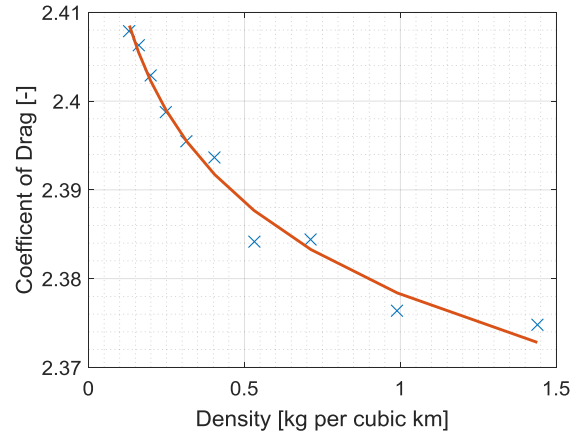

Figure 7: Variation of Drag Coefficient with Density (Reference Area = 0.25)

3.2. Thrust

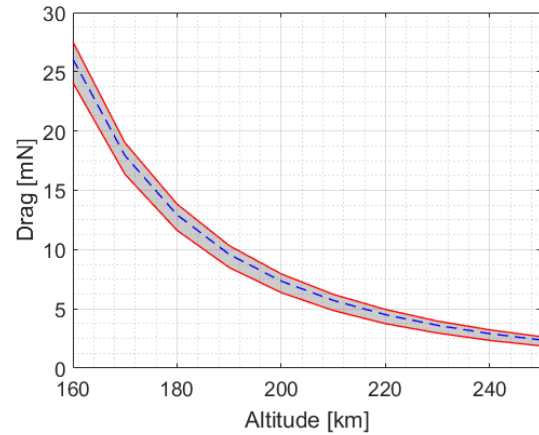

Figure 8: Expected drag range with Altitude for High Solar activity (based on DS2V calculations)

The model of C_D for the Satellite (equation 3) and the maximum and minimum atmospheric densities at 190 km (from NRLMSISE-00) can be used to calculate the maximum and minimum drag during high solar activity. The results show that maximum drag is 10.3mN and minimum is 8.52mN (Figure 8). This is a narrow range and so it appears that a fixed thrust setting as suggested for the Continuous-thrust regime and Daytime thrust regime is a valid assumption.

Table 4: Summary of Thrust requirements for a satellite in a nominal orbit of 190 km altitude

Drag/Thrust [mN]	
Expected Drag at 190km (DS2V)	
Min	8.52
Average	9.60
Max	10.3
Thrust in Noon SSO (GMAT)	
Continuous Thrust	8.62
Daytime Thrust	15.1
Thrust in Dawn-Dusk SSO (GMAT)	
Continuous Thrust	8.40
Daytime Thrust	10.5

From the GMAT simulations, it was found that the thrust required to maintain the orbit under a continuous burn regime in both noon and dawn-dusk Sun-synchronous Orbits (and therefore the average drag experienced by the satellite) was lower than the drag (and therefore expected thrust) predicted by the DSMC simulations shown in Table 4. The Earth is an oblate spheroid with a radius that varies by about 30km from equator to the poles, therefore even if the orbit is perfectly circular, the altitude above the local sea level will vary over the course of the orbit. Furthermore by considering the non-sphericity of the Earth's gravitational field, it was found that the satellite's altitude varies by as much as 20 km (the orbital radius varies by about 8km) (Figure 9).

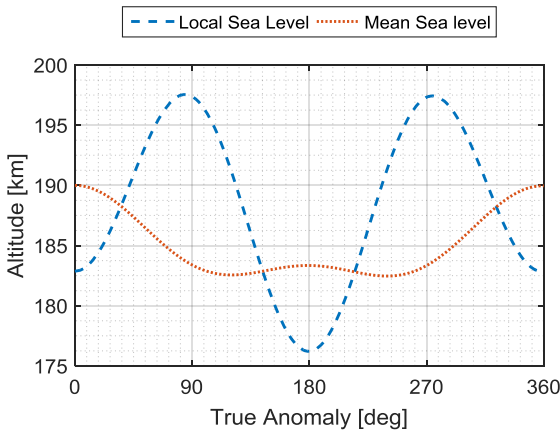

Figure 9: Variation of Altitude around the Orbit referenced to Local Sea Level and Mean Sea Level

The average density values for the DSMC simulation were calculated based on a constant altitude, whereas, as can be seen from Figure 9, the satellite's altitude in the GMAT simulation varies resulting in the lower thrust (by 10%) under a

continuous burn regime. However, this should not have any serious impact on the GMAT simulation as the coefficient of drag used in the simulation was varied based on the density the satellite was experiencing (equation 3). The nominal altitude of the orbits in the GMAT simulation have been measured from the Earth's mean radius.

3.3. Thrust Requirements

If the thrust is considered in isolation, there are two key requirements for the electric propulsion:

1. The system must be capable of supplying the required cruise thrust to maintain the nominal altitude under the selected thrusting regime.
2. The system should have sufficient excess thrust to be able to recover the satellite from loss of altitude following a malfunction.

The amount of excess thrust which the electrical propulsion can provide will define the limit of recoverability of the system (the lowest altitude from which the satellite can be rescued).

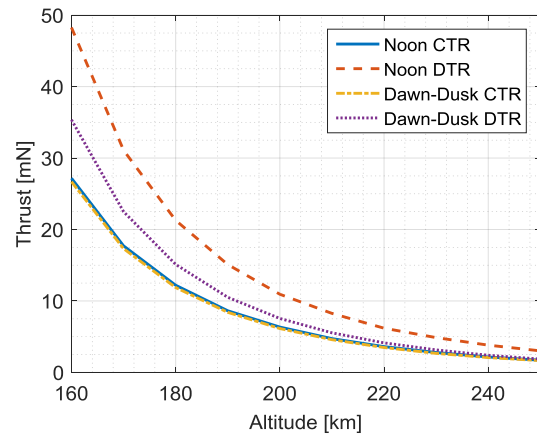

Figure 10: Variation in thrust requirements with altitude for Noon (LTAN=1200) and Dawn-Dusk (LTAN=0600) using a Continuous Thrust Regime (CTR) and Daytime Thrusting Regime (DTR)

Applying these requirements to a nominal altitude of 190km, it was found that, in order to maintain the orbit, the electrical propulsion system would need to provide 8.62mN and 8.04mN for the noon and dawn-dusk Sun-synchronous orbits respectively (Table 4) under a continuous burn regime. If a daytime burn regime is adopted, these values rise to 15.09mN and 10.51mN respectively.

Left unpowered at 190km, the satellite would begin losing altitude at a rate of 48.7m per orbit (for

reference, the Ballistic Coefficient for the satellite at this altitude is 167kg/m^2). After approximately 205 orbits (12 days) the nominal altitude of the satellite will have fallen to 180km. This should provide ample time to regain contact and recover the satellite. Taking 180km to be the limit of recoverability for a nominal 190km orbit, under a continuous burn regime, the propulsion system would need to provide at least 12.2mN and 11.9mN for the noon and dawn-dusk Sun-synchronous orbits respectively (21.3mN and 15.12mN under Daytime burn regime). In general for a 190km orbit this means the system would need to provide at least 1.5 times the cruise thrust for the chosen burn regime (Continuous or Daytime Burn) in order to perform the raising manoeuvre.

3.4. Possible Thrusters

In principle, the five propulsion systems listed in Table 5 should all be capable of providing the thrust required to maintain the altitude of a 190km orbit under a Continuous-burn regime in both Sun-synchronous Orbits. However, it is possible that not all of them will be able to satisfy a requirement to recover the satellite from an altitude 10km below its nominal altitude. For example, to satisfy a recovery limit of 180km for a nominal 190km orbit, only the T5, RIT-10 and the T-40 would be able to provide sufficient excess thrust (Table 6).

*Table 5: Comparison of potential Electrical Propulsion Systems
(I=Ion, GI=Gridded Ion, HET=Hall Effect Thruster)*

	Type	Thrust Range [mN]
T5 [9]	GI	1 – 20
RIT-10 EVO [10]	GI	5 – 25
Hayabusa-IES [11]	GI	6.3 – 9.0
RMT [12]	I	2 – 12
T-40 [13]	HET	5 – 20

Only the RIT-10 would be able to provide sufficient thrust for the more demanding Daytime burn regime for both Sun-synchronous Orbits and have sufficient excess thrust. Therefore for a nominal altitude of 190km, a propulsion system with a thrust range similar to the RIT-10 (max of 25mN) should be selected. In the next section, the implications of lower altitudes are examined.

3.5. Going Lower (Down to 160km)

One of the aims of this study was to establish the lowest altitude at which a satellite of this size could operate.

Table 6: Lowest recoverable altitude for the EP systems in Table 5 in a Noon SSO

	Continuous Burn [km]	Day Burn [km]
T5	168	182
RIT-10 EVO	162	176
IES	189	207
RMT	181	197
T-40	168	182

Table 6 shows the lowest altitudes from which the satellite could recover from using different propulsion systems. In other words, the T5 could maintain a 182km noon Sun-synchronous orbit under a day burn regime but it would have no margin to recover the orbit if it fell any lower. Engines with more thrust are available, such as QinetiQ's T6 [14], and it may be possible to double up smaller thrusters. This will, however, also increase the power required by the system and thus the solar array area. If the solar arrays become too large they may impact the drag. Higher thrust requirements also increase the fuel demand and thus will limit the life of the satellite. More work will be need to assess the power and mass budget for operating in VLEO.

4. Further Work

As is discussed in section 3.5 above, thrust alone would not constrain operation in VLEO as there are systems that can provide thrust down to 160km and beyond. The next step would be to perform a more complete sub-system analysis taking into account for instance the mass and power budgets of the microsatellite. This should provide a more refined limit on the system and help to define the operational envelope of microsatellites in VLEO.

5. Conclusion

This study has shown that under a Continuous-burn regime, the difference in the thrust required for a Noon SSO and Dawn-Dusk SSO was very small (about 1%). However, there was a significant difference between the constant thrust required under a continuous-burn regime (and therefore average drag experienced by the satellite in the GMAT simulation) and the drag predicted by simulations in DS2V. This was mainly due to variations in the satellite's altitude over the course of the simulated orbit. Additionally, it was seen that under a daytime burn regime, more thrust was required to maintain a noon SSO than a Dawn-Dusk

SSO (between 37% and 62% more from 160km to 250km). This was primarily as a result of the shorter eclipse in Dawn-Dusk SSO.

In general, a propulsion system would need to provide sufficient thrust margin above the cruise requirement to ensure it can recover from a lower orbit following a malfunction. It was shown that, regardless of LTAN or thrust regime, at a nominal altitude of 190km a propulsion system would need at least 1.5 times the cruise thrust to ensure it could recover from an altitude of 180km. Based on these requirements, it was concluded that for a 190km orbit a propulsion system with a thrust range similar to the RIT-10 EVO (max 25mN) (Table 5) should be selected.

Finally, many other aspects remain to be researched, including subsystem aspects, power and fuel. But from a thrust perspective, no immediate problem was identified that would prevent a satellite from operating at an orbit of 160km.

6. Acknowledgements

The authors would like to thank the following for their helpful comments: Piero-Francesco Siciliano, Cheryl Collingwood, Daniele Frollani, Andrew Bacon, Claire Parfitt from Thales Alenia Space UK. The views expressed in this paper do not represent those of Thales Alenia Space UK. The work performed here was funded under EPSRC grant number 15220191.

7. References

- [1] A. Green, "An Ultra Low Altitude Synthetic Aperture Radar Micro-Satellite," University of Bristol Master's thesis, 2012.
- [2] A. Grasso, "Feasibility Study of an Ultra-Low Altitude Hyperspectral Micro-Satellite," University of Bristol Master's thesis, 2012.
- [3] GOCE Flight Control Team (HSO-OEG), "GOCE End-of-Mission Operations Report," ESA, 2014.
- [4] K. Fujita and A. Noda, "Aerodynamics of Satellites on a Super Low Earth Orbit," in *AIP Conference Proceedings*, Kyoto, 2008.

- [5] Naval Research Laboratory, "NRLMSISE-00," 2000. [Online]. Available: <http://ccmc.gsfc.nasa.gov/modelweb/models/nrlmsise00.php>. [Accessed 12 January 2016].
- [6] European Cooperation for Space Standardization, *ECSS-E-ST-10-04C*, ESA Requirements and Standards Division, 2008.
- [7] T. I. Gombosi, *Gaskinetic Theory*, Cambridge University Press, 1994.
- [8] G. A. Bird, *The DSMC Method*, CreateSpace Independent Publishing Platform, 2013.
- [9] C. H. Edwards, N. C. Wallace, C. Tatro and P. Van Put, "The T5 Ion Propulsion Assembly for Drag Compensation on GOCE," [Online]. Available: http://earth.esa.int/goce04/goce_proceedings/46_edwards.pdf. [Accessed 02 April 2016].
- [10] Airbus Defence & Space, "Ion Propulsion Systems," [Online]. Available: <http://www.space-propulsion.com/spacecraft-propulsion/ion-propulsion/>. [Accessed 02 April 2016].
- [11] K. Nishiyama, S. Hosoda, K. Ueno, R. Tsukizaki and H. Kuninaka, "Development and Testing of the Hayabusa2 Ion Engine System," in *30th International Symposium on Space Technology and Science*, Kobe, 2015.
- [12] M. Capacci, G. Matticari, G. E. Noci, A. Severi, A. Ricciardi and F. Svelto, "Radiofrequency with Magnetic field ion Thruster (RMT): review of the Engineering Phase accomplished under ASI Contract," [Online]. Available: http://erps.spacegrant.org/uploads/images/images/iepc_articledownload_1988-2007/2003index/0289-0303iepc-full.pdf. [Accessed 17 April 2016].
- [13] HPEPL, "T-40 Hall Effect Thruster," [Online]. Available: <http://mwalker.gatech.edu/hpepl/thrusters/t-40-het/>. [Accessed 02 April 2016].
- [14] J. S. Snyder, D. M. Goebel, R. R. Hofer and J. E. Polk, "Performance Evaluation of the T6 Ion Engine," *Journal of Propulsion and Power*, vol. 28, no. 2, pp. 371-379, 2012.